

**An Answer
to America's
Energy Deficit**

Fifth Edition

Donald L. Smith, CEO
TransWorld Energy
8110 Bent Oak Lane
Spring, Texas 77379
Fax (281) 370-4911

Donald L. Smith
TransWorld Energy
Spring, Texas 77379
January, 1997
Fax 218 - 370 - 4547

Dear Reader,

Welcome to the Fifth Edition of "An Answer to Americas Energy Deficit"
It has been translated and republished in all major languages, including
Japanese, Chinese, Russian, German, Dutch, Finnish and numerous others.
More than 30,000 copies are in circulation at this time.

The style is intended to be accessible without the usual intellectual
posturing, common in the scientific community. It is intended to establish
an intuitive base for understanding Electric Energy. Therefore, opening a
new panorama of opportunity for the inventors to be.

Scientific Notation showing overunity, is and has been available prior to
Newton. It is conveniently ignored for various reasons. The formulas are
simple, honest and basically not very sophisticated.

Working from the knowledge base here presented the extensions thereof
would do Tesla proud. Most of what is presented here has been in place
since mid 1800's. Putting it in words so that it becomes useful has not.

Now that a burr has been placed under the saddle, perhaps more interesting
things will occur. I wish you well for your voyage into the future.

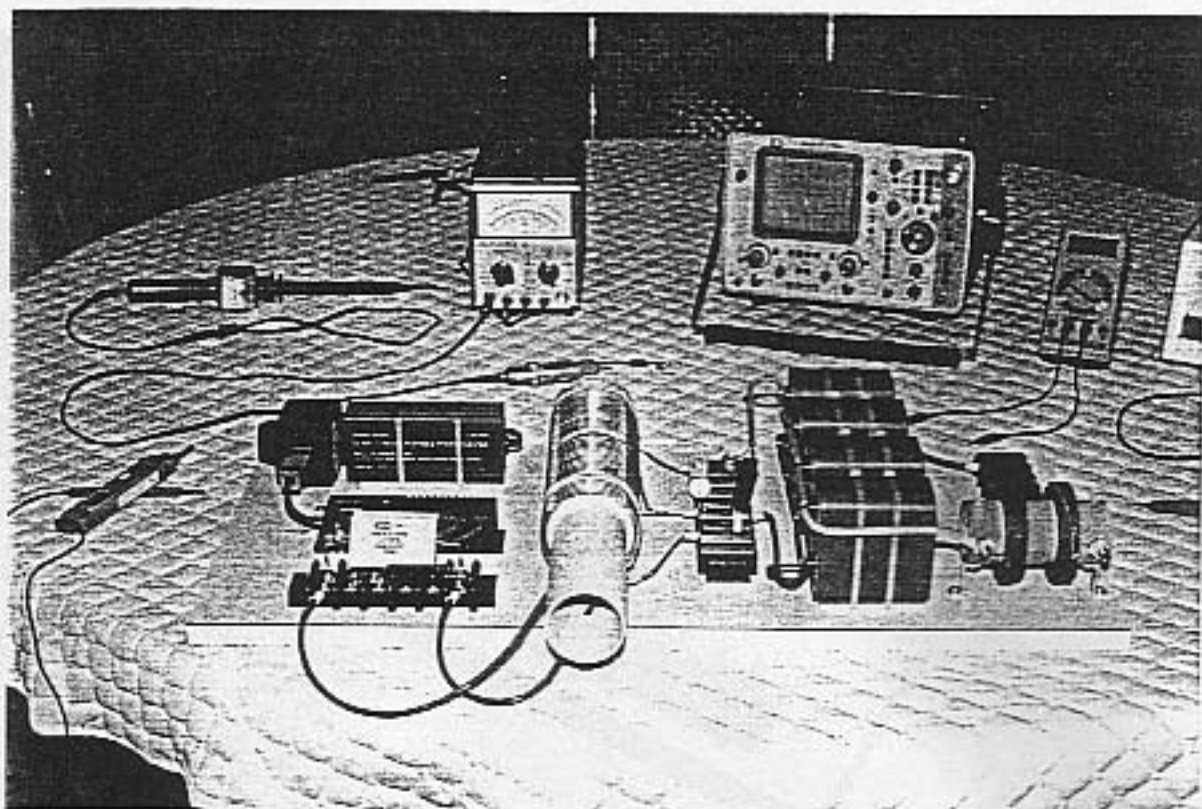

6,000 VOLTS AT 3 AMPERES, (18 KVA)

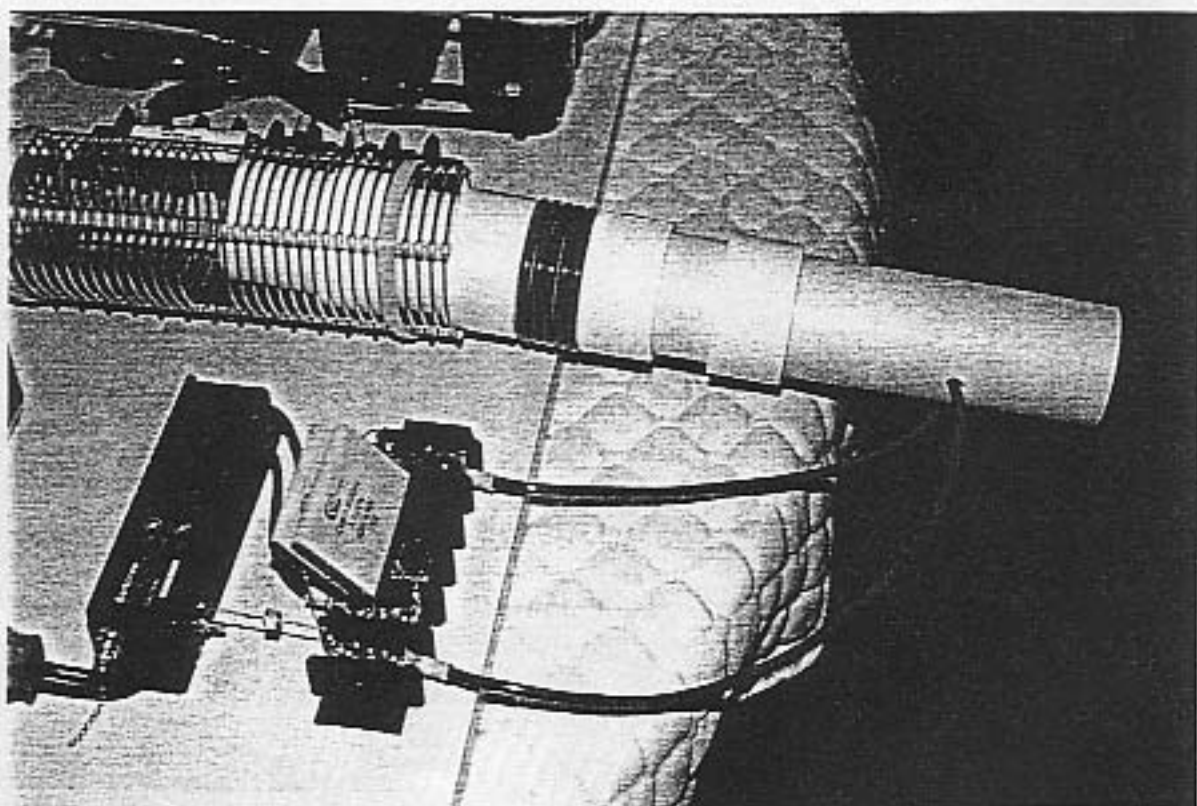

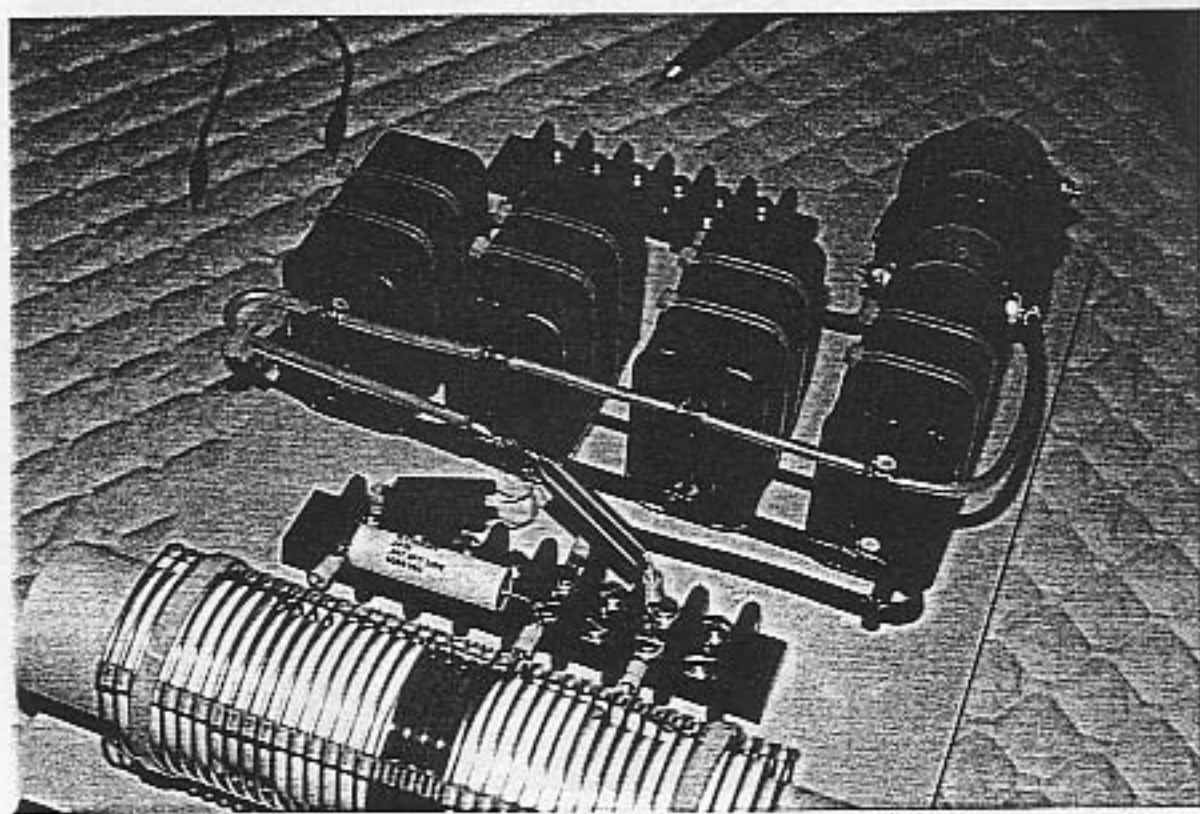
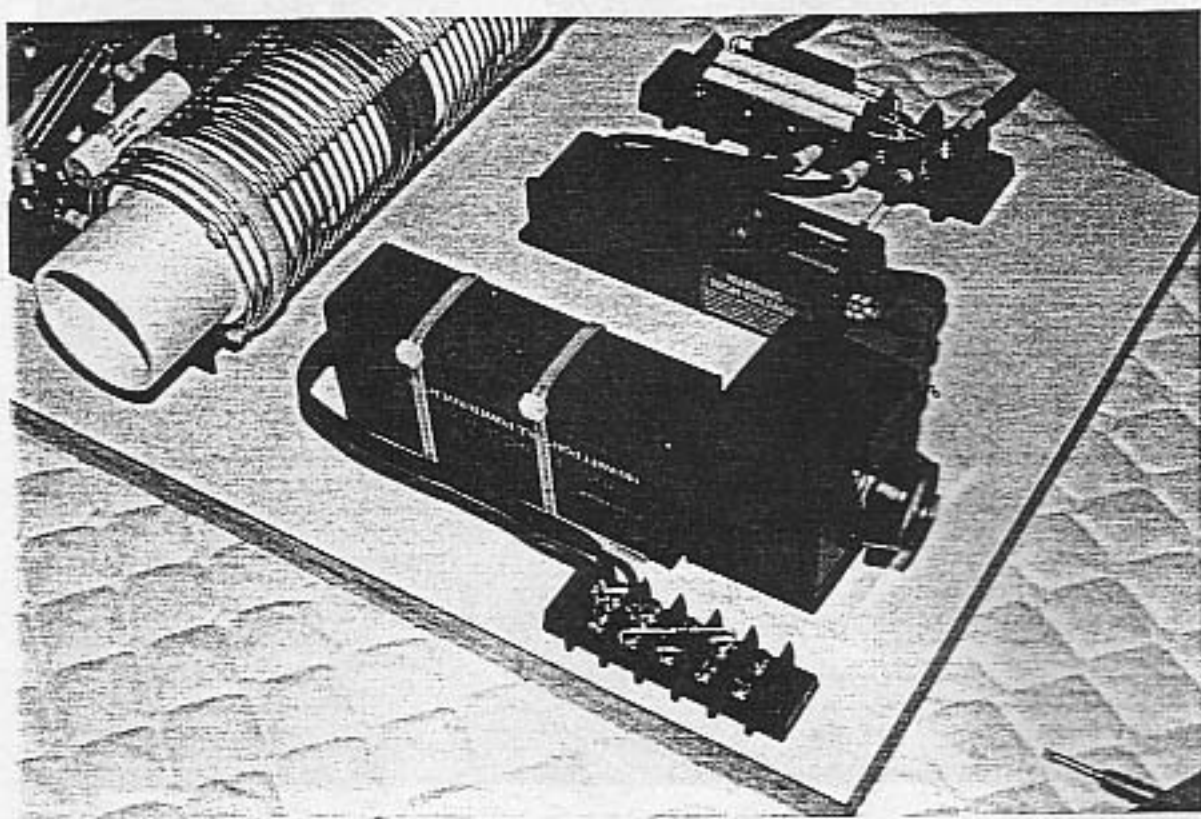

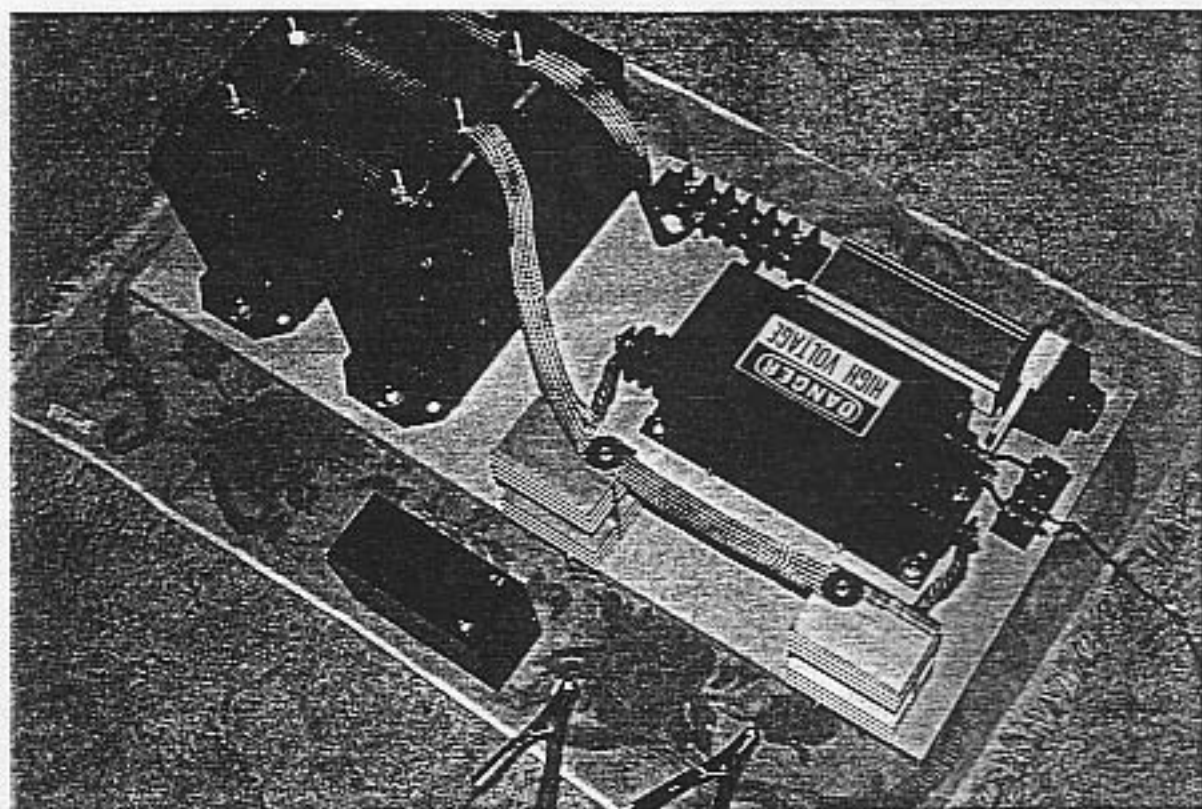

15,000 VOLTS AT 3 AMPERES, (45 KVA)

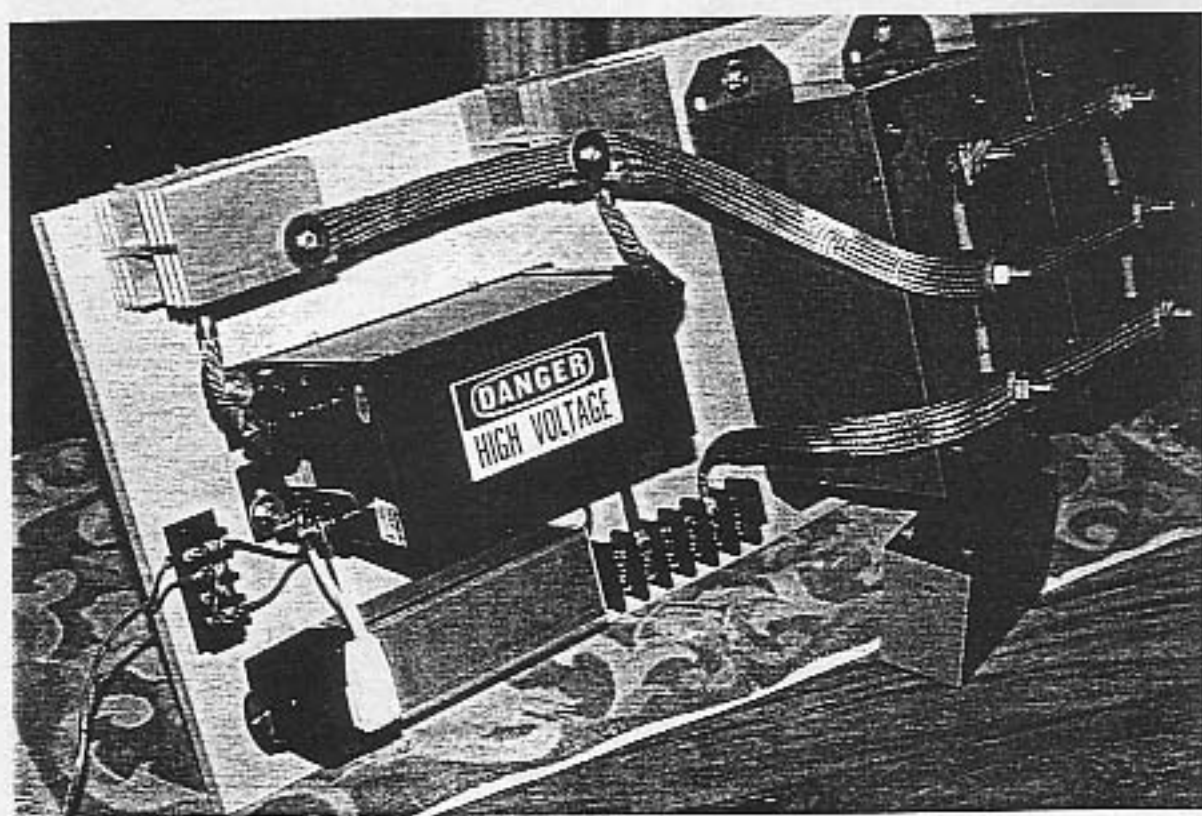

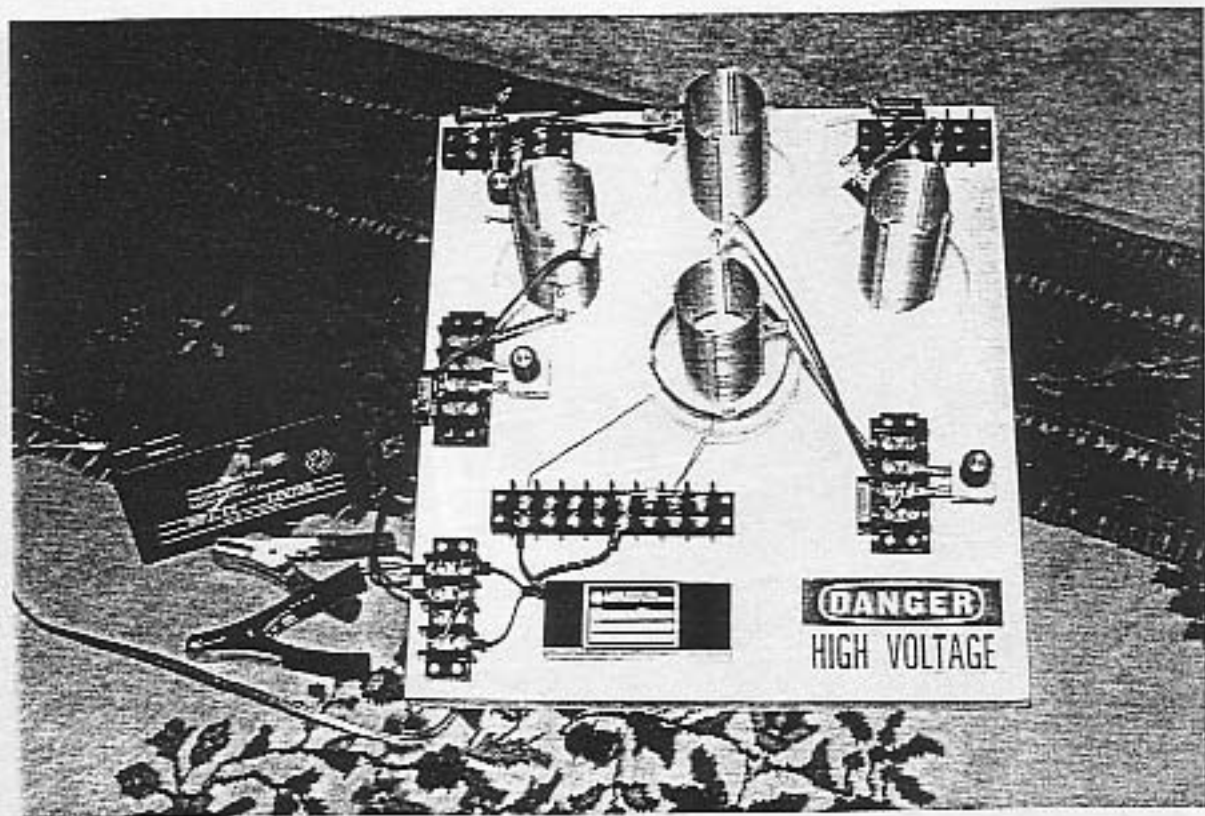
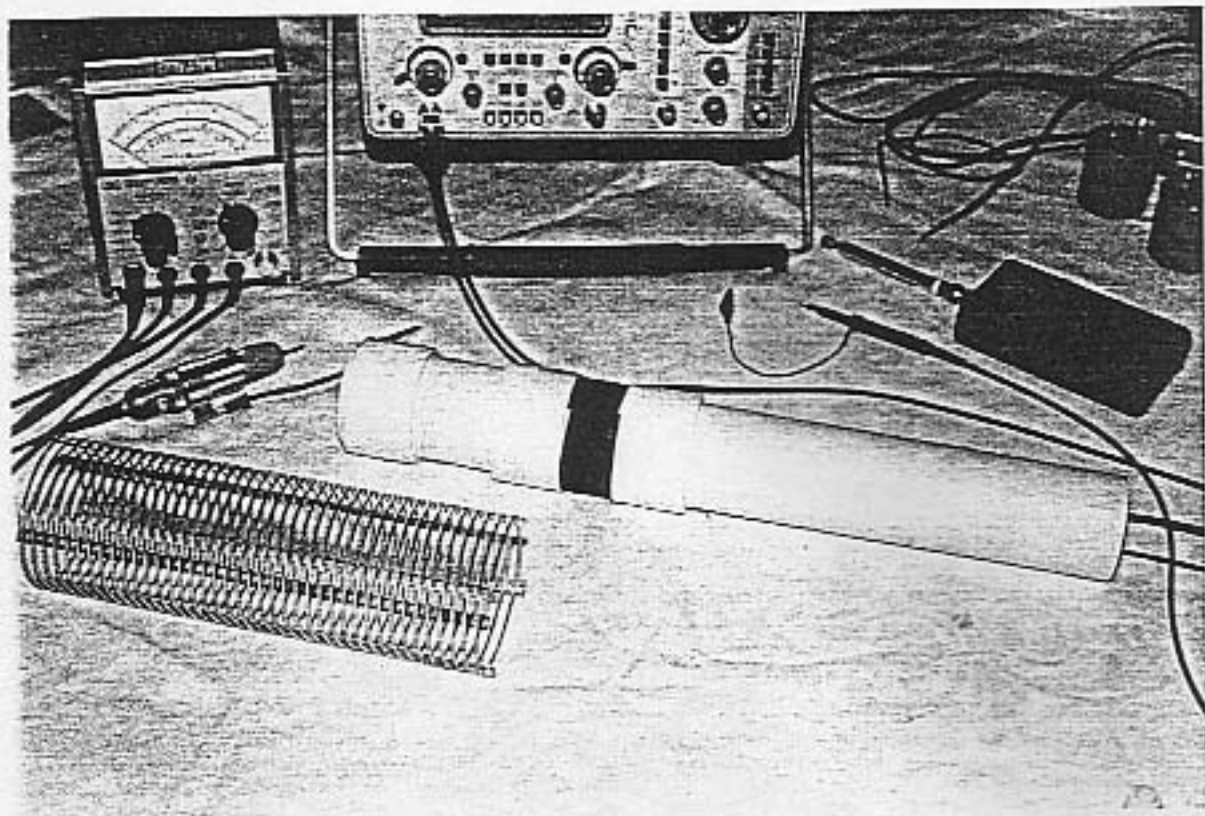

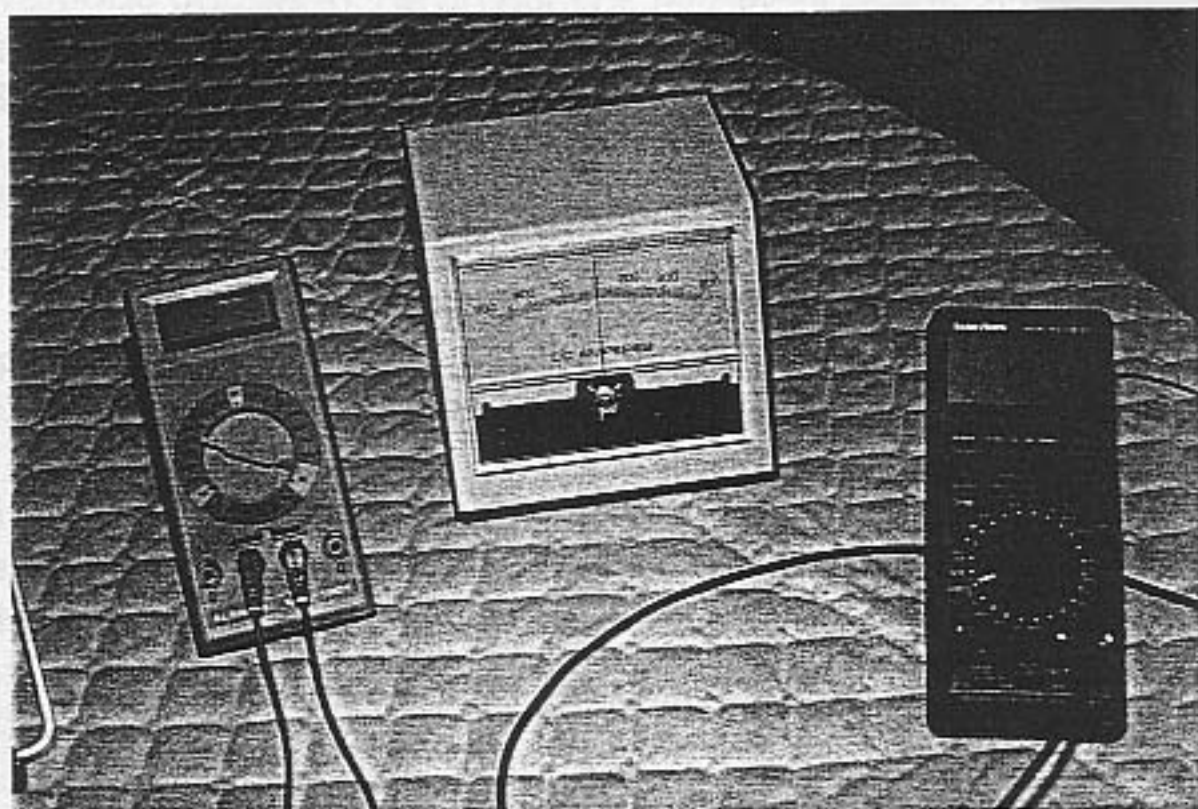
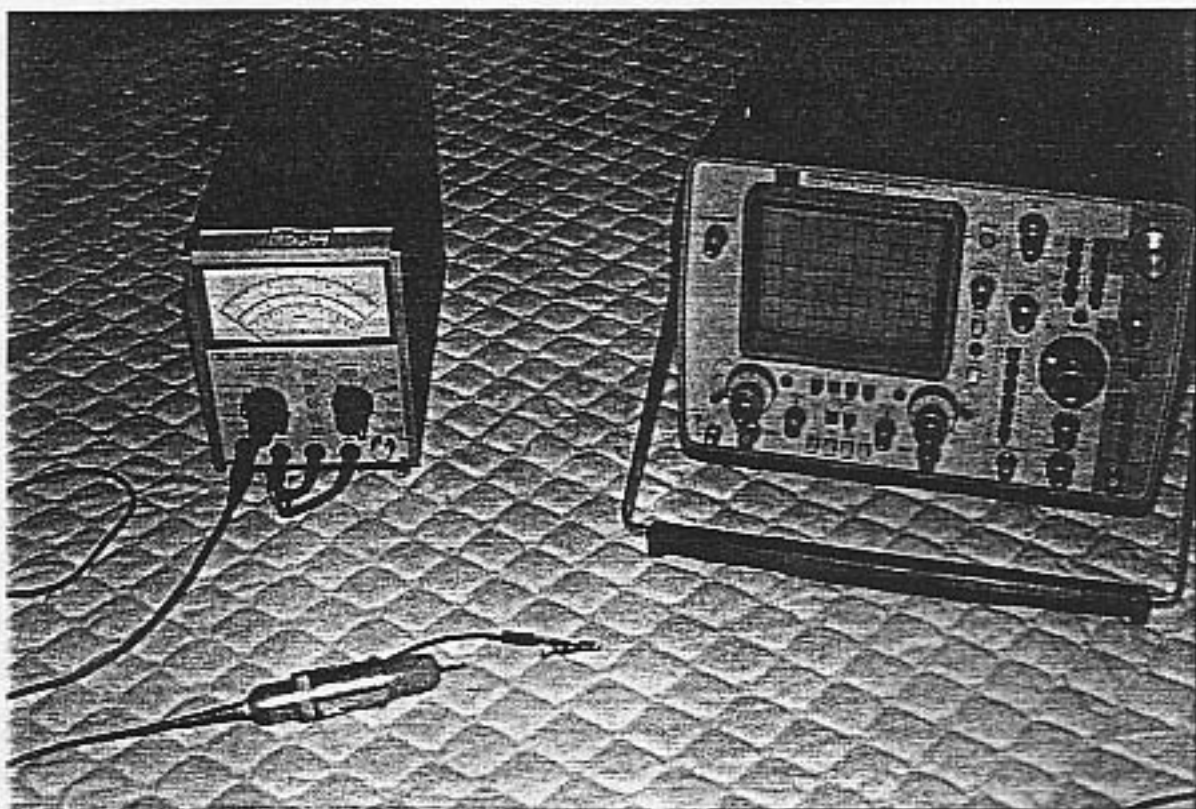

MEM

Electrical Energy Generating System

Description and Function:

Generation of Electrical Power requires the presence of electrons with various methods of stimulation, yielding magnetic and electrical impulses, collectively resulting in Electrical Energy (Power). In place of the mechanical - coils and magnet system, present in conventional electrical power generation, visible moving parts are replaced by resonate magnetic induction, using radio frequency. Transfer of energy by resonate induction is related to the ratio of the square of the cycles per second. The Energy System, here presented, operates at millions of cycles per second verses the conventional 60 C.P.S.'s. This tells us that it has a size advantage over conventional methods. The same advantage applies to the amount of electrical energy output. Therefore the Device is small in size and produces large amounts of Electrical Energy. The Electrons acquired are from the surrounding Air and Earth Groundings, being the same source as in conventional methods. This is accomplished by magnetic resonate radio induction.

Applications:

This Electrical System adapts nicely to all Energy Requirements. It is a direct replacement to all now existing Energy Systems. This includes such things as Manufacturing, Agricultural, Home Usage, Office Complexes, Shopping Centers, Rail Transportation, Automobiles, Electrical Power Grids, Municipalities, Subdivisions, and Remote Areas. Briefly, only the imagination is the limiting factor.

Physics of Avalanche

Avalanch Phenomenon is universal, undeniable and has profound effects when related to various displays of energy found in nature.

Head in the sand Physics varies from a religious (Quantum) experience to intellectual (Orgasmic) Posturing, in a profane attempt at ignoring facts.

Those with open Circuit tendencies allow for the possibility of a first rain drop, first snow flake, first shot in a war, first grain of sand in bringing down a mountain by avalanche., ad infinitum.

Those with closed Circuit (Minds) conveniently put the world in a box, what goes in, comes out, end of question !

The very same laws of nature which allow for one cell to become a human, one small explosion to ignite a hydrogen bomb applies to all matter. All matter and energy have a shared expressions of being, composing the real world and the related natural laws defining it.

A closed circuit world is a necessity for preserving the status quo and keeping the special interest, special. We are all familiar with a time in history when only the establishments viewpoint was permitted, anything otherwise was immediately destroyed (Dark Ages).

Only a slight glance will tell the most stupid that the dark ages is still with us very much present as relates to vested interest. No where is it more obvious than in the US. Patent Office. How much difficulty do you think General Electric Company would have in getting a Patent verses an individual ?

The deck and field is stacked against the individual and profoundly tilted so as to maintain those already in power. Greed must protect it's self.

Just as a stupid person repeats the same mistake over and over, the intelligent person learns from his mistakes and a wise person learns from mistakes of others, the world goes on.

Which brings us to the task at hand. The Field of Science profligates by notation, that which does not, is not. As an accommodation to the closed circuit and dark age constituency, herein is an offering of a piece of best Roquefort presently available.

The closed circuit coffin already has several stakes driven through it. Isaac Newton (1642 - 1727) with the help of Charles Coulomb (1736 - 1806) provide us with the square laws which are based on an open circuit. Oliver Heaveyside (1850 - 1925) provided us with Energy equals mass times the square of it's acceleration. Albert Einstein (being an insider) took credit for Heavyside's work and the rest is history.

Mathematically Leonardo Fibonacci (1170 - 1230) of pisa demonstrated very clearly that, which directly translates from laws of nature, an orderly form of progression.

This same ordering of nature occurs in all radio type circuits. No where is it more obvious than in air core induction transformers and radio tubes.

Leaning on that which is already a part of history, the writer will propose that which is of nature :

Energy (a unit of being - static)
Energy Out (plus self acceleration - kinetic) *

* = must be squared at each stage of increase.

Simply stated, the unit of being , biological, physical or chemical when accelerated relates to Fibonacci and the square laws mentioned.

Energy and mass being one, indicates a very small portion can , and does initiate vast changes.

Scientific Notation Formulas to Be Supplied Later

(Input is solicited)

Dedicated Fax Line 281 - 370 - 4911

ELECTRICAL ENERGY GENERATING SYSTEM

Patent Pending 08 / 100,074

NOTE: IF THE RISE CONNECTOR (2) WISES LENGTH IS A WAVE LENGTH COMPONENT OF THE L-1 OR L-2, FREQUENCY, THE BATTERY WILL RECHARGE IT'S SELF AT THE SAME TIME IT IS BEING USED, TO SEE THIS SUBSTITUTE TWO OPPOSING LIGHT EMITTING DIODES, THEY SHOW THE DIRECTION THE ELECTRONS ARE MOVING, DC ELECTRONS OUT AND RADIO FREQUENCY ELECTRONS INTO THE BATTERY.

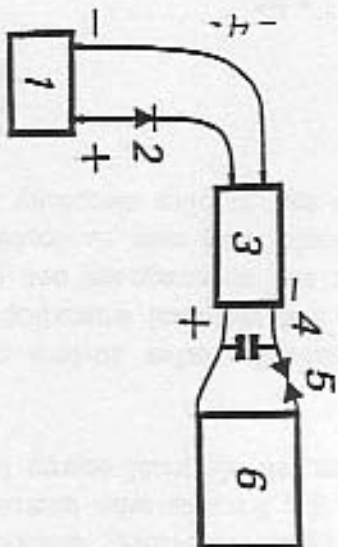

1. Galcel, 6 or 12 Volt.
2. Diode, Pos., use a Varactor.
3. High Voltage Module, Constituting the L-1 and L-2 Coils.
4. Capacitor, TDK 10.9 Pf., 30 KV.
5. Spark Gap, Small Engine Spark Plug, Gap = .0025 in.
6. Induction Transfer Coil L-3.
7. Induction Receiving Coil L-4.
8. Voltage Control Shunt.

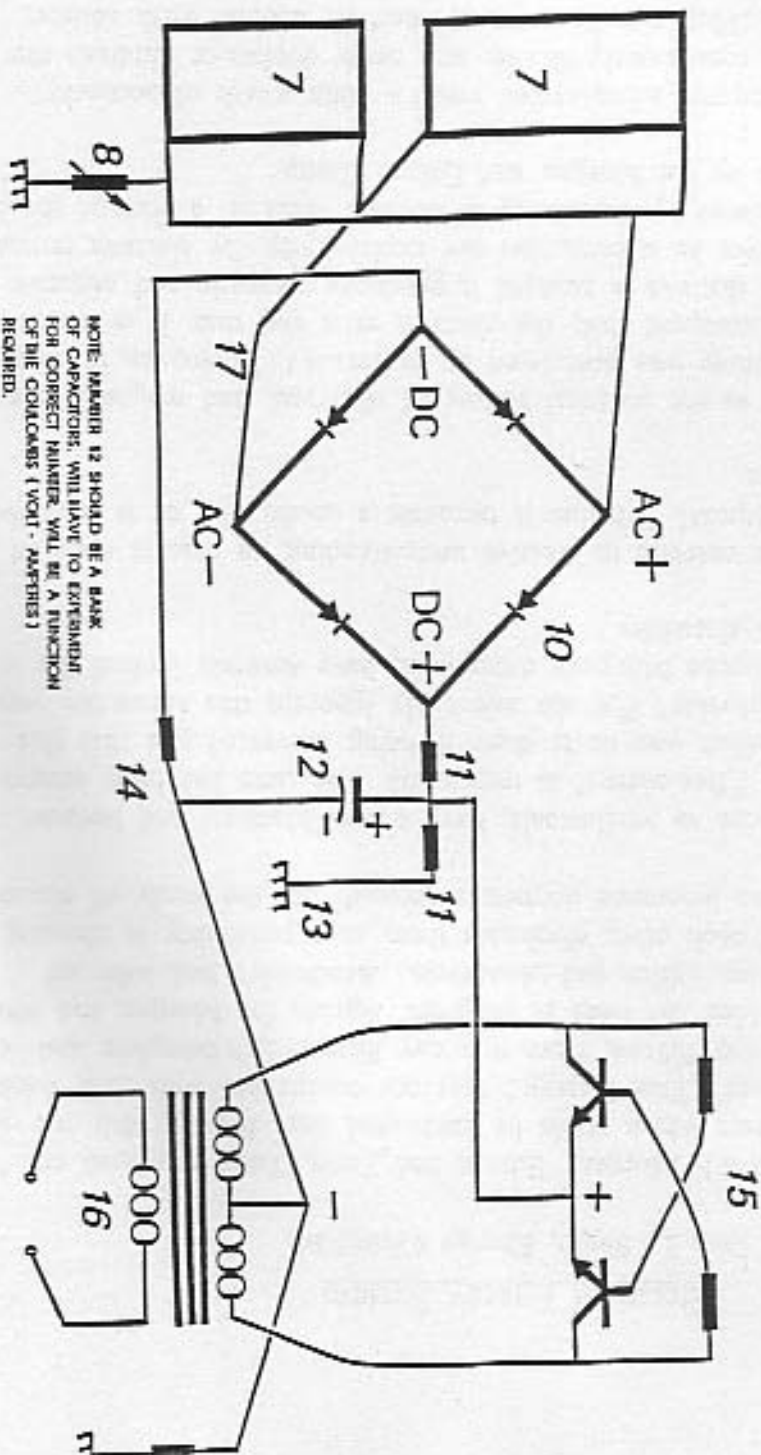

NOTE: MAKING 12 SHOULD BE A BANK OF CAPACITOR, WILL HAVE TO EXPERIMENT FOR CORRECT NUMBER, WILL BE A FUNCTION OF THE COILS (VOLT - AMPERES) REQUIRED.

10. Diode Bridge, 200 Nanosecond, R.F., > 100 KV.
11. Voltage Divider Circuit, corrects voltage for next stage.
12. Capacitor, electrolytic, smooths out DC + ripple effect.
13. Earth Ground.
14. Voltage Divider Circuit, corrects voltage for Transformer
15. Inverter Circuit, DC + In and 60 CPS to Transformer
16. Output from Transformer to Load (Work).
17. Center Top

Electrical Energy System

Don L. Smith, Energy Consultant

At a meeting between J.P. Morgan, Edison and Tesla, Tesla proposed an Electrical Energy System which could be connected into directly, with out using a meter. Tesla's Idea of "Free Energy" was not compatible with their thinking. Courtesy of Morgan and Edison, from that day foreword, a complete and total bastardization of the Idea has been in progress. Agents for Morgan and Friend include the U.S. Patent Office and Academia. Academia's bad habit of incestuous quoting of each other eliminates them as a possibility in cleaning up the mess. This selective ignorance permeates through out the study of electricity.

Many persons, otherwise as intellectuals, have a total blackout and become jabbering idiots when "free energy" is mentioned. The term has been amended to say, "something which was never there is being harvested and that this violates the laws of physics". For the selectively ignorant this seems the way to run. Those who choose Morgan's drum beat, have severely limited the possibilities built into electricity.

This paper will be an exercise in creative understanding, in placing updated knowledge at your disposal. Whether it becomes a useful tool or is selectively ignored is your choice.

Electrons are defined as the practical source of electrical and magnetic energy. The electron as a particle was postulated by professor J. Thompson in early 1900's. It is now universally accepted that, the electron exist and that it is the source of electricity. When the electron is agitated it produces magnetic and negative electrical energy. Physics as it exist, can not explain why the electron remains in tact and is not diminished by the energy it releases. This is a part of the built in ignorance provided by the Morgan and Edison Camp.

A volts worth of electrons, when cycled yields a volts worth of electricity. This can be repeated continuously forever and never deplete or diminish the electrons in question. They simply return to their air and, or earth source, waiting to do the whole thing, again and again. Therefore, electrical energy is available, any and every where humans go. Persons who intercede for profit, set the cost of electrical energy. Otherwise, all electrical energy is free, Morgan and Edison be dammed.

Improving upon Professor Thompson's postulation, other obvious character further defines the electron. It has both magnetic and electrical emanation resulting from a right and left hand spin. Since magnetic and amperage are one package this suggest, that electrons in a natural none ionic state exist as doublets.

When pushed apart by agitation one spins and supplies electricity and the other

spins and provides magnetic (amperage) energy. When they reunite, we have Volts X Amperage = Watts. This Idea, until now, has been totally absent from the knowledge base.

The times an electron is cycled sets the collective energy potential present. The electrical equivalent of $E = MC$ squared is $E = (\text{Volts X Amperes}) \times \text{Cycles Per Second squared}$. Those who choose, are now free to head for the bushes and make their usual contribution to humanity.

Prior to Tesla, there was a large group of persons in Europe, who were building resonate coil systems related to medical usage. Amperage was dangerous in their coil systems. The Tesla Coil is only the Voltage half of their coil system, as will be demonstrated herein.

A short list of those active (1860-1880 onward) in resonate high frequency coil systems include the Curies, Roentgen, Ruhmkoff, Oudin, Hertz, Levassor, Dumont, D'Arsonval and many others.

Peugeot, Panhard-Levassor, Bollee, Renault and others had successful electric automobiles in production using A.C. motors. Various electrically powered airships including the Dirigible France were in service.

D'Arsonval, Professor of Experimental Medicine at the College of France, invented the electrocardiograph, oscilloscope, amp and volt meters, thermography and numerous other medical applications of high frequency electricity. As early as 1860, he was building high frequency coil systems, used in his experimental work.

There is a strong connection between the work of Tesla and the above mentioned.

Electric vehicles of all sorts, dominated until the 1920's, when the electric starter motor made the internal combustion engine practical. Prior to that, upon cranking, it frequently would break the owner's arm. At that point the use of batteries as a source of power was replaced by oil.

The 240V circuit has two hot wires and one safety-ground wire. Switches and fuses are installed in the hot lines. The two hot wires are necessary for the operation of 240V welders and motors. The safety-ground wire, connected to the metal frame of the equipment or motor and to the neutral bar, does not carry current unless a "short" develops in the motor or welder. If a short should occur, one of the circuit protectors will burn-out or open, thus opening the circuit.

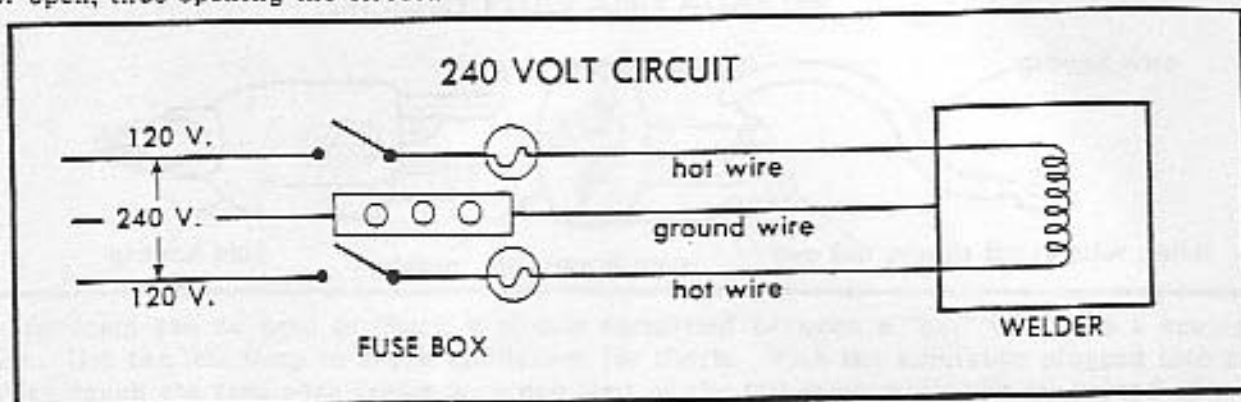

The voltage on a 240V circuit is measured by fastening a lead on the voltmeter to each of the hot wires. Voltage between either hot terminal and the neutral bar will be one-half of the voltage between the two hot wires. The number of amperes flowing can be measured by clamping an ammeter around either of the hot wires.

7. Safety Grounding Electrical Equipment

Refer back to the 240V circuit and note the ground wire from the metal frame to the neutral bar. The following illustration shows proper safety grounding when operating a drill in a 120V circuit. The safety-ground shows proper safety grounding when operating a drill in a 120V circuit. The safety-ground wire may be bare, but a three-wire romex is recommended. Safety-ground wire in three-wire romex is usually green in color. A current-carrying neutral wire should never be used for a safety-ground. Likewise, a safety-ground wire should never be used as a current-carrying hot or neutral wire.

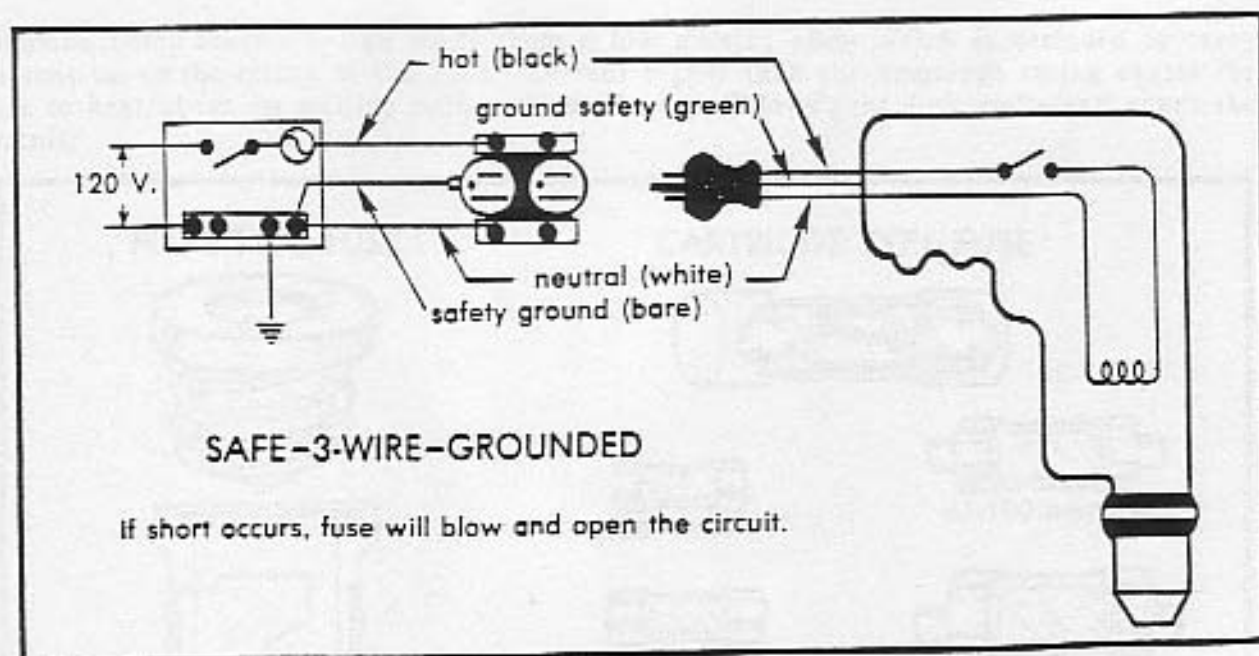

Using grounded receptacles and a safety-ground on all circuits will allow the safety-grounding of appliances when they are plugged into the outlet. An adapter must be used to properly ground appliances connected to receptacles not safety-grounded. If an adapter is used, the green pigtail wire must be connected to a known ground to give protection from electrical shock should a short occur.

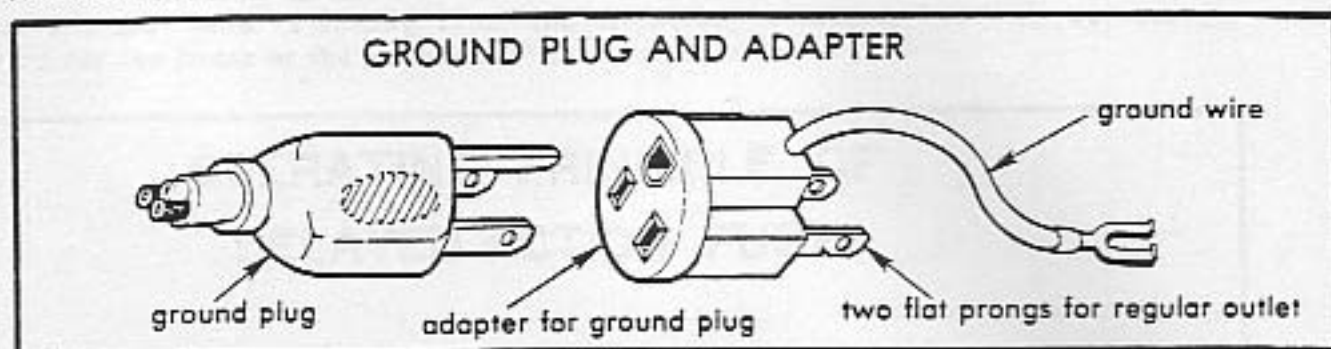

A test lamp can be used to check a circuit completed between a "hot" wire and a neutral wire. Use the test lamp to check appliances for shorts. With the appliance plugged into an outlet, touch the appliance frame with one lead of the test lamp while the other lead of the test lamp is grounded to a water or gas line. If the test light does not burn, reverse the appliance plug and check with the test lamp again. If the light burns, a short exists. (Hot wire is touching the frame of the appliance.) Unplug the appliance and repair or discard it.

8. Electrical Circuit Protection

Electrical circuits should be protected from an overload of amperes. Too many amperes flowing through an unprotected circuit will generate heat, which will deteriorate or melt the insulation and possibly cause a fire. The number of amperes that a given conductor can carry safely depends upon the kind and size of wire, type of insulation, length of run in feet, and type of installation. Charts are available in reference texts giving allowable current-carrying capabilities of various conductors.

The four types of circuit protection are common fuses, fusetrons (time-delay), fustats (two-part time-delay), and circuit breakers. Fuses are of two basic types, plug and cartridge.

Common fuses contain a link made from a low melting alloy which is designed to carry current up to the rating of the fuse. Current higher than the amperage rating causes the link to heat above its melting point. When the fuse "blows", the link melts and opens the circuit.

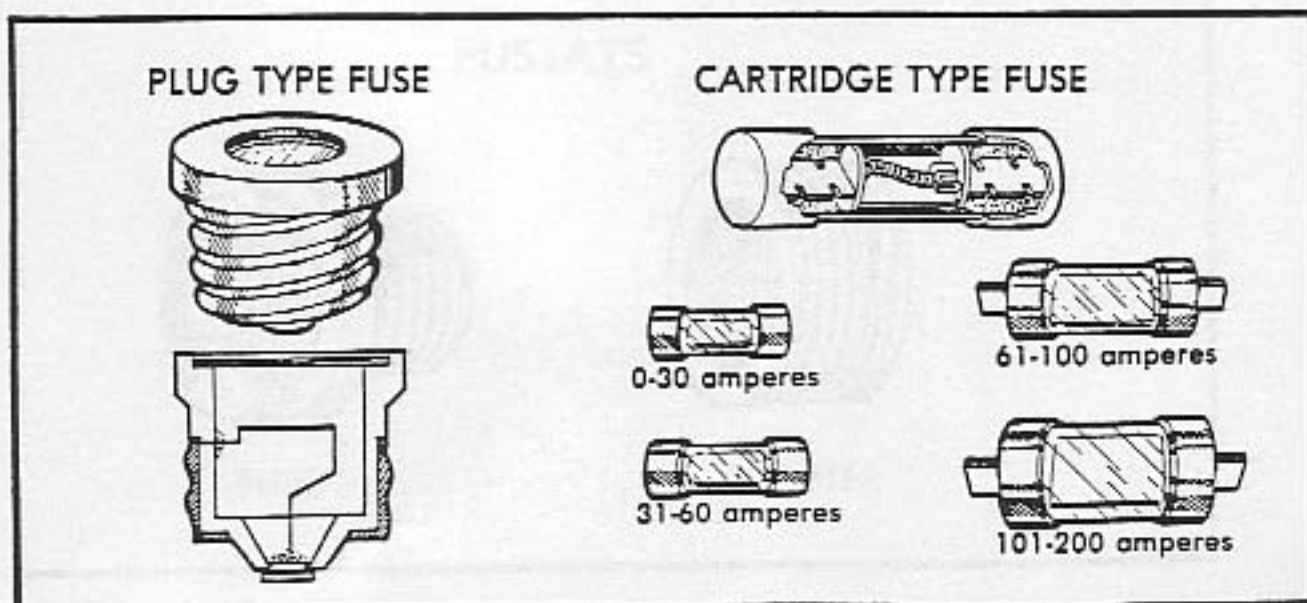

Fusetrons (time-delay fuses) are made to carry a temporary overload, such as the overload caused by the starting of an electric motor. The fuse, however, still provides protection for the circuit, and a short circuit will melt the fuse link. If a common fuse is used, the fuse link will melt every time an electric motor starts. The use of a larger ampere common fuse will prevent the "blow" resulting from the temporary overload, but will not provide protection for the motor or the circuit.

OPERATING PRINCIPLE OF DELAYED ACTION FUSE

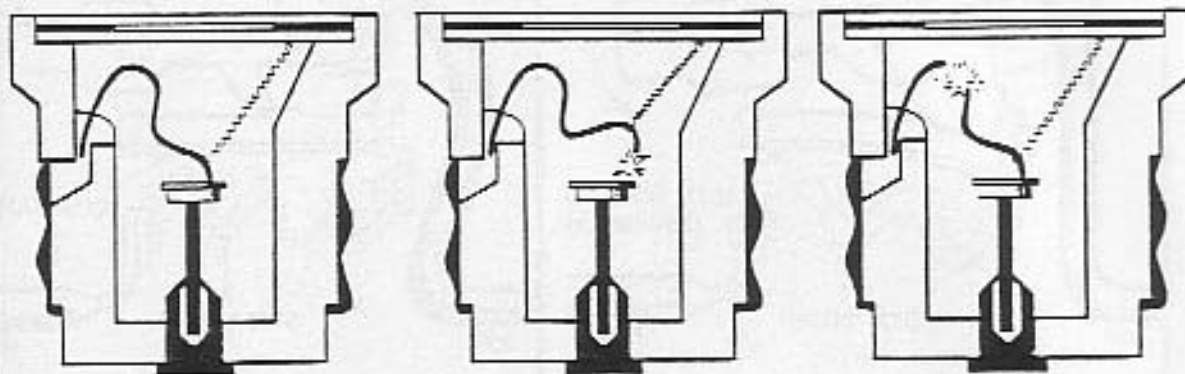

TIME DELAY

CONTINUED OVERLOAD

SHORT CIRCUIT

Fustats, nontamperable fuses of the time-delay type, have a different size base and require a special adapter that is screwed into the standard fuse socket. After the adapter is installed, it cannot be removed. For example, the installation of a 15-ampere adapter allows only the use of 15-ampere or smaller fuses.

FUSTATS



FUSE

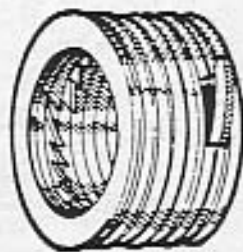

ADAPTER

Circuit breakers eliminate the replacement of fuses and are commonly used even though a circuit breaker box costs more than a fuse box. Circuit breakers are of two types, thermal and magnetic. The thermal breaker has two contacts held together by a bi-metal latch. An overload of current causes the bi-metal strip to become heated, the latch releases, and the points spring open. After the bi-metal strip cools; the switch is reset; and service is restored.

CIRCUIT BREAKER OPERATION

CLOSED

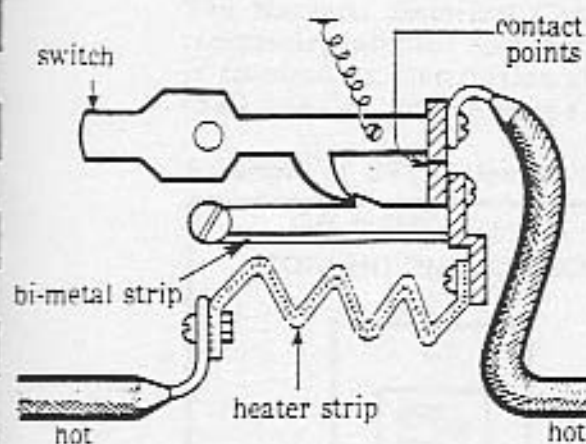

OPEN

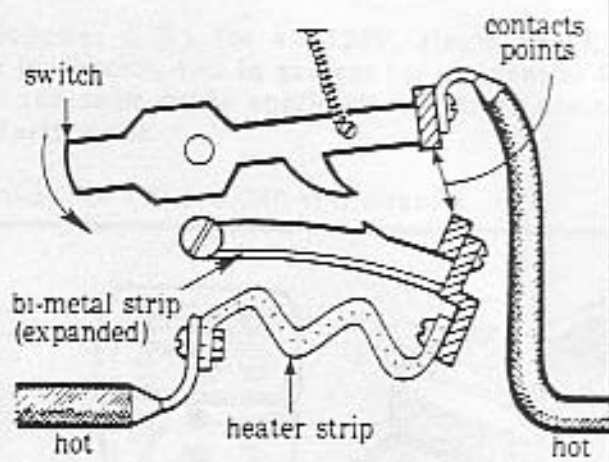

The magnetic breaker has contacts that are held together by a latch which is released by the action of an electromagnet. The amount of current flowing through the circuit will determine the size of the electromagnet. This type of breaker is reset by moving the toggle switch to the "on" position.

The following diagram shows the parts of a circuit breaker.

CIRCUIT BREAKER

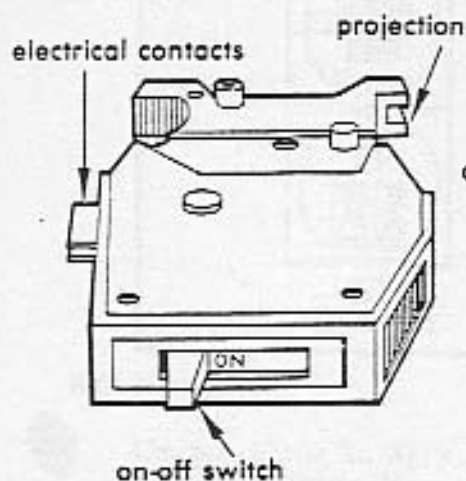

CIRCUIT BREAKER

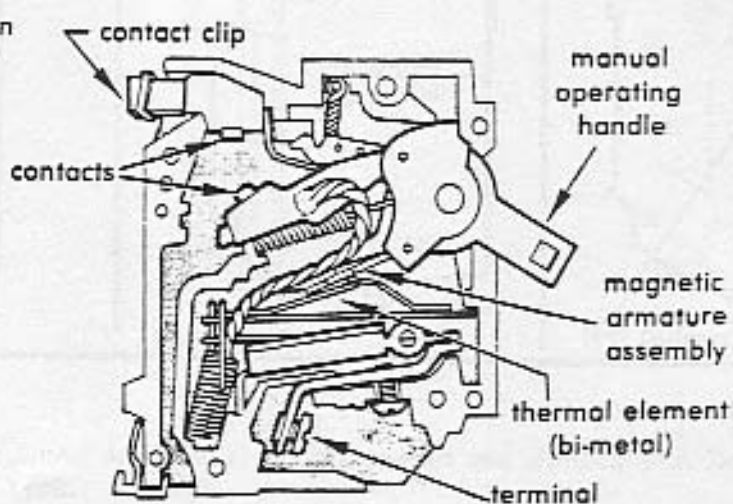

9. No Fault Grounding

Fuses and circuit breakers are safety devices which limit current (amperage) in a circuit. Their main function is to protect equipment and wiring from overload. Ground fault circuit interrupters (GFI) are designed to protect humans, equipment, and/or electrical systems from injury or damage if electricity flows in an unintended path (a short).

A GFI is a very sensitive device that functions by comparing the current moving in the "hot" wire with that in the neutral wire. If these two currents are not equal, a fault exists, and current is "leaking" out of the circuit. If the difference in current between the two wires is 5/1000 of an ampere or greater, the GFI will open the circuit, shutting off the power and eliminating any shock hazard.

The National Electrical Code requires GFI's for all 120V, single phase, 15 and 20 amp receptacles installed outdoors, in bathrooms, and in garages for residential buildings. A GFI is required at construction sites and some other applications. After correcting the circuit fault, the GFI may be reset for further use.

A variety of GFI equipment is made for 120 and 240 volt circuits.

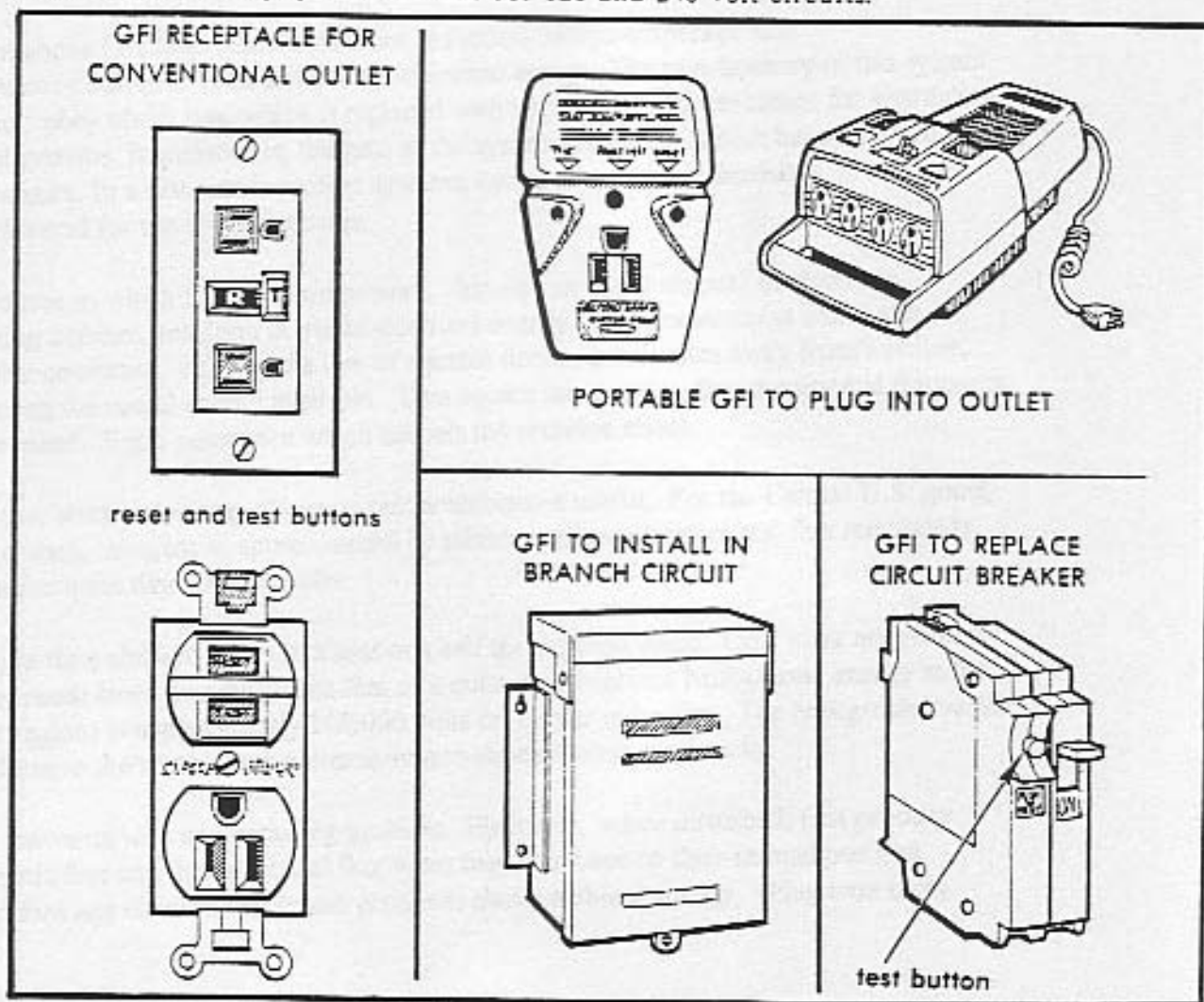

References:

Cooper, Elmer L., *Agricultural Mechanics: Fundamentals and Applications*. Delmar Publishers, Inc., Albany, New York.

Electrical Wiring - Residential, Utility Buildings, Service Areas, AAVIM, Athens, Georgia.

The establishment's carpet has some rather large lumps under it. Coulomb's and Newton's inverse square law is politely ignored and it's opposite is allowed only the most abstract status. Without opposites we have no definition.

The source value of a remote flux reading, requires the squaring of the distance, times the remote reading, to obtain the original value. The opposite of this, being the derivations relate to Energy equals Mass times the Velocity constant squared. The electrical equivalent, being Energy equal capacitance times voltage squared and Energy equals induction times amperes squared. Flux lines increase as the law of squares and then activate electrons (energy) not previously a part of the sum. The cumulative capacitance and inductance as the distal ends of a Tesla coil are approached, results in energy greater than the input being present. This Energy is real when properly understood. It can be safely measured by magnetic flux methods and electrostatic voltmeters, based on the inverse square law.

As seen above flux lines result both from Induction-henrys-amperage and capacitance-coulombs-volts and define electrical energy. The non-linearity of this system does not obey ohm's law, which is replaced with impedance and reactance for alternating current systems. Impedance is the sum of the system resistance, which becomes zero at resonance. In a resonate induction systems, cycles per seconds increases, invokes a second round for the law of squares.

The degree to which flux lines are present, disturbs an equal amount of electrons, upsetting ambient, resulting in useful electrical energy. The frequency at which the disturbance occurs, obeying the law of squares further accelerates away from ambient, increasing the useful energy available. Two square law entities, flux density and frequency are evoked. Enter resonance which cancels the resistive effect.

Only that electrical energy above or below ambient is useful. For the Central U.S. going east to west, ambient as approximated by electro-static voltmeters and flux methods is on a solar quite day 200,000 volts.

At night time ambient drops to about one half the daytime value. On a solar active days it may reach more than five times that of a quite day. Ambient background energy at the polar regions is approximately 500,000 volts on a solar quite day. The background varies as relates to the north-south component and the east-west continuum.

This leaves us with an interesting problem. Electrons, when disturbed, first produce magnetic flux and then electrical flux when they spin back to their normal position. Therefore any electron movement produces above ambient energy, being over unity.

As a source of Electrical Energy, non-ionic electron doublets exist in immense quantities throughout the universe. Their origin is from the emanation of Solar Plasma. When (spun or pushed apart) ambient is disturbed, they yield magnetic and electrical energy. The rate of disturbance (cycling) determines the energy level achieved. Practical methods of disturbing them includes, moving coils past magnets, or vice versa. A better way is the pulsing (resonate induction) with magnetic fields and waves near coils.

In coils systems, magnetic and amperage are one package. This suggest, that electrons in a natural non-ionic state exist as doublets. When pushed apart by agitation one spins left, yielding (Volts-potential) electricity and the other spins right, yielding (Amperage-magnetic) energy. One being more negative than the other. This further suggest that when they reunite, we have (Volts X Amperes = Watts) useful electrical energy. The above idea, until now, has been totally absent from the knowledge base. Amperage as previously defined is then flawed.

Electron Related Energy

	<u>Energy Available</u>	<u>Method of Storage</u>	<u>Common Unit</u>	<u>Units of Measure</u>
Electrons	Spin Electrical	Capacitor/Coulombs	Volts	Flux Units
	Gravity	Momentum	Torque	Ergs
	Magnetic	Coils/Amp. turns	Amperes	Flux Units
	Light	Laser	Lux	Teslas, Gauss, Gammas, Oersteds
	Impact resistance	Various	Fahrenheit/Celsius	Photons
	Heat			Temp

Left hand spin of Electrons results in Electrical Energy and right hand spin results in Magnetic Energy. Impacted Electrons emit visible Light and heat

Electrons as a source of energy have been moving and yielding magnetic and electrical flux since the beginning of time and will continue to do so, till the end of time. They are however, never diminished. Therefore, an electron is an excellent example of an over-unity source of energy.

The sea of Continuum "Ether", governed by the Law of Squares is from it's electrical and magnetic character composed largely of right and left handed electrons.

Tesla Coil Geometry *

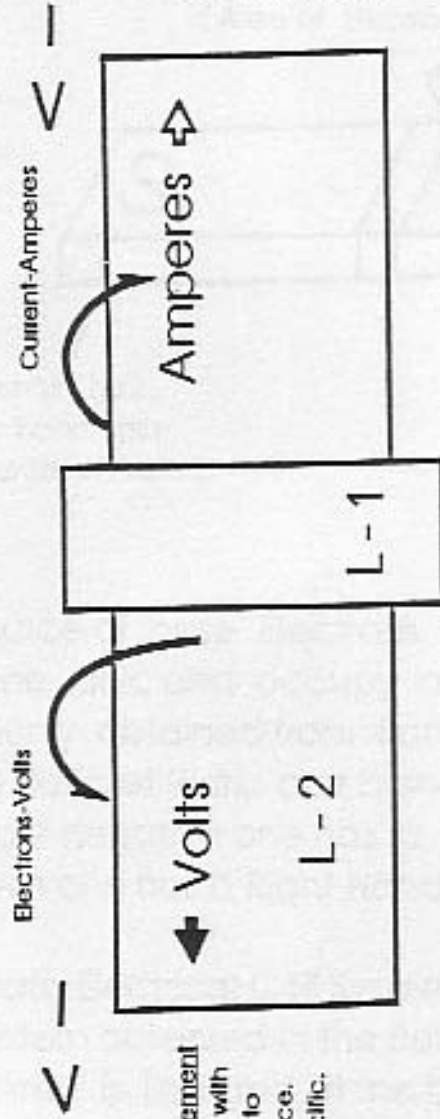

Correct Method of Measurement
Use the Inverse square law with an Electrostatic Volt Meter to measure from a safe distance. they are frequency nonspecific.

Correct Method of Measurement
Use the Inverse square law with Hall-Effect devices to measure from a safe distance, they are normally frequency nonspecific. The magnetic field they measure converts directly to Amperage

Volts dominate if the L-1 Coil is far right
Volts and Amperes about equal if L-1 Coil centered

This End Has Greater Voltage
Distributive Capacitance at Maximum
Capacitance-Coulombs-Voltage
Voltage has Electrons spinning to Left

This End Has Greater Amperage
Distributive Inductance at Maximum
Induction-Henrys-Amperage
Amperage has Electrons spinning to Right

Volts represent the more negative and Amperes the less negative. Therefore the electrical charge of more negative must seek the less negative to regain ambient.

* Contains proprietary information related to Patent Procedure
Geometry - properties of lines, surfaces and solids

Derivation of Magnetic and Electrical Power

Analogous Relationships:

1. Potential Power is present in a bar magnet as shown.

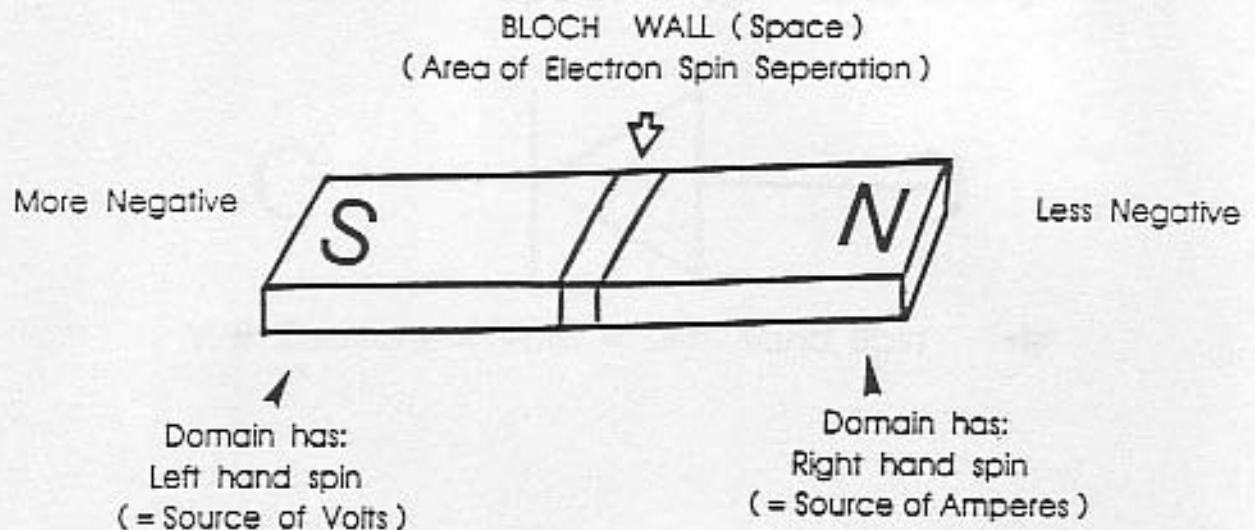

2. The Source of these Electrons being from the Solar Plasma, are none ionic and occupy all Free Space. They are commonly obtained from Earth and Air Groundings. They exist in Doublet Pairs, one being more negative than the other. The more negative one has a Left Hand Spin. The less negative one has a Right Hand Spin.
3. Resonate Electrical Coil Systems (Tesla) are Analogous to the System observed in the Bar Magnet (above). The Bloch Wall Area is Located at the base of the L-2 Coil. The Left Spin portion (Voltage Only) part of the Coil predominates. The right hand spin portion (Magnetic-Amperage) portion is mostly absent.

4. The Electrical Circuit equivalent of the Bloch Wall is a Diode. Electron Doublets once separated must recouple, resulting in useful energy, (Volts X Amperes = Watts) = Power.

I = Current = Amperes = Right Hand Spin \Rightarrow

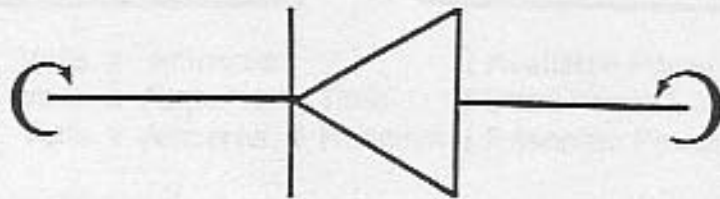

V = Electrons = Volts = Left Hand Spin \leftarrow

Power Triangle

Power System 1

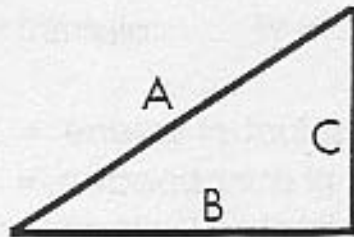

Power System 2

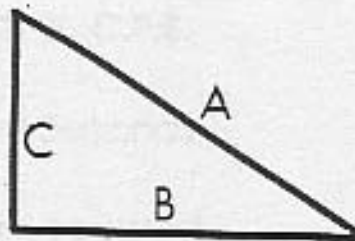

A: Volts x Amperes (Available Power).
B: Volts x Amperes x Time (Used Power).
C: Volts x Amperes x Reactive (Resonate Power).

1. "A" and "B" represent the establishments View of electrical power. Random movement of electrons in these systems, mostly cancel out each other. Therefore, always resulting in less energy out than in. This damping, or wasteful concept of energy, is a source of much pleasure for the establishment.
2. "C" (Volt Amperes Reactive V.A.R.), all the electrons move in the same direction at the same time. Therefore, near unity energy output by resonate induction transfer. This is the room temperature equivalent of super conductivity.
3. Resonate induction transfer from one power system allows, other resonate induction systems to duplicate the original source, which in no way diminishes the original source. Air core coils systems, when a part of a functioning transformer unit confirm this. A less perfect illustration would be, the number of radio devices or televisions, concurrently running in no way diminishes the output source.
4. Resonate induction transfer disturbs a large number of adjacent electrons which were not a part of the original source. The pulsating (pumping effect) then incorporates the newly available extra electrons into the ongoing energy generation source-system. A near unity energy system of resonate air core coils and the extra acquired electron-energy source constitutes an over unity system.

Don Smith
pwr1.sam

Energy stored, times the cycles per second, represents that being pumped by the system. Capacitors and inductors temporary store electrons.

Capacitor formula: $W = .5 \times CE \times C.P.S.$

W = energy in Joules (Watt Seconds)

C = capacitance in farads

E = applied potential in volts squared

Inductor (Coil) formula: $W = .5 \times LI \times C.P.S.$

W = energy in Joules (Watt Seconds)

L = inductance in henrys

I = current in amperes squared

Both one henry and one farad equal one volt. The higher the cycles per second, including the squaring of the flux lines cause a large increase in the amount of energy being produced.

The above combined with a resonate energy induction system (all electrons moving at the same time in the same direction), make the next move into overunity practical.

The dampning process of conventional electrical power generation has all the available electrons randomly bouncing, mostly canceling out each other. In this System, useful energy available is a very small percent of that present.

In the resonate induction system a very high percent of the energy present is useful. When resonate, (ohms-Impedence-Z) becomes zero and all energy present is available, undegraded. Ohms is load or wasted energy and amperes is the rate of wasting.

Induced Electrical Energy System

Collection and transfer of energy requires temporary storage, which occurs as capacitors and coils of a resonate circuit are cycled, off and on. The frequency at which the capacitors and coils are pumped determines the amount of electrical energy that moves onward.

The amount of Energy transferred relates directly to the density of lines of flux present. The Kinetic Energy Formula is helpful in establishing the amount of energy present. This formula squares the velocity times mass. In the case of electrical energy, intensity of voltage and amperes times cycles per second replace velocity.

Note the "acceleration" of the Voltage "E" and Amperage "I", which increase as none linear, then obeys the Law of Squares.

Each unit of increase causes a squaring of the flux lines present. The amount of energy transfer caused by this increase in flux lines is demonstrated below.

Increase in Flux Lines Present Symbolized

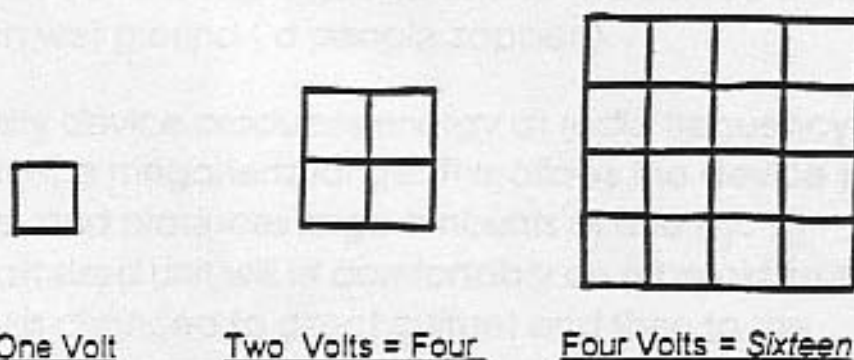

In resonate air core coil energy transfer, the increase in flux lines present disturbs more electrons than previous, resulting in over unity energy being present and available.

Using the previous information, now apply it to an air core coil, resonate transformer energy system. L-one and L-two coils are now present. L-one has a smaller number of turns and is several times the diameter of L-two. Input from a 12 volt gelcel* source produces 8,000 volts with low (wasted energy) amperage into 4 turns of coil L-one. Each turn of L-one then acquires 2,000 volts of resonate potential. Each turn of L-two is then exposed to the electric flux of 2,000 volts. Each turn at the bottom end of L-two acquires 2,000 volts. The flux lines are squared and are additive as the voltage and amperage progresses towards the top end of L-two's many turns.

A huge amount of flux lines not previously present occur at the top end of L-two. These flux lines excite the electrons nearby in it's earth and air and groundings. This high level of excitement above the ambient causes a large amount of electrons not previously a part of the energy present to become available. At this point overunity is present in large amounts.

The bubble gum between the ears response to this is, lots of volts but no amperes. Please recall that amperage is wasted energy, and that until wasting occurs there are no amperes.

A good way to demonstrate this is let the bubble gum crowd, put their hand on the high voltage end of the device while standing on wet ground (a people zapper).

This overunity device produces energy at radio frequency, ranging into the megahertz range. This allows the device to be small in size, and produces large amounts of energy.

A megawatt sized unit will sit comfortably on a breakfast table. This energy is changed to direct current and then to the desired working frequency.

* A high voltage laser module.

Electrical Power Generation / Points of Reference

Useful Electrical Power is Generated when Electrons from Earth and Air Groundings are disturbed by the movement of coils and magnets with reference to each other. The resulting electrical and magnetic energy is then changed to joules [watt seconds, Volts x Amps x Seconds]. Each forward electron movement results in a magnetic impulse and each return movement causes an electrical impulse. The composite of the electrical energy impulsed from these electrons yields useful energy [Power].

Let the above electron movement be represented by a room full of ping pong balls randomly bouncing. Most of the energy present cancels out by random impaction. This is the Classic Under Unity approach to Electrical Power Generation, sanctioned by the Establishment.

In the Electrical Energy Generation System here presented, the resonate Electrons are all moving in the same direction at the same time. This allows Near Unity Electrical Power to Develop. This is the room temperature equivalent of super conductivity.

The Energy System here presented consists of a properly adjusted and functional resonate air core coil tank . The Electrical Energy is stored in capacitors and magnetic energy in the coil system. From Maxwell and others, we know that electrical related energy has an equal amount of magnetic energy associated with it..

* The formula which establishes the Useful Energy of the Inventors System is : *

$$\text{Joules} = [0.5 C \times V^2] \times \text{C.P.S. squared}$$

$$\text{Joules} \{ \text{Volts} \times \text{Amperes} \times \text{Seconds} \} \text{ Watt Seconds}$$

C = Capacitance in microfarades

V = Potential in Volts

C.P.S. = Cycles per second

Transfer of Electrical Power by Resonate Induction is a direct function of the squaring of the cycles per second. For example square 60 C.P.S. and then square the radio frequency C.P.S.'s of the System here presented. Obviously One Million Cycles per Second transfers more energy than Sixty Cycles per second. The Sanctioned Method of Electrical Power Generation uses the 60 C.P.S. Method. Usage of the 60 C.P.S., and the random scattering of the Electrons System assures the Establishment of it's desired Under Unity Goal.

This random bouncing of the Electrons is the Ohms of Ohm's Law and is used to establish the rate of dissipation and or Load [Work].

In the Resonate Tank Induction Energy Transfer System here presented Impedence [system resistance] replaces the conventional ohm's usage. At Resonance impedence becomes Zero and the full force and effect of the Energy Transfer occurs. This is superconductor conditions at room temperature. At radio frequency the Electrons do not pass through the conductor as at lower frequencies. These Electrons encircle the conductor and are free of the conductor's resistance.

Let the Establishments Power Generation System be "A" and the Inventors System here presented be "B".

"A". Given 60 C.P.S. at 120 Volts using 10 microfarad Capacitor

$$\text{Joules} = [0.5 \times .000,010 \times 120 \text{ squared}] \times \text{C.P.S.'s squared}$$

$$[120 \text{ x's } 120 = 14,400.]$$

$$[.000,010 \times 14,400. = .144]$$

$$[.144 \times 0.5 = .072]$$

$$[.072 \times 3,600 = 259.2]$$

If using the Inventor's Resonate Induction System the Electrical Power available would then be 259.2 Joules [Watt Seconds]. Using the Establishment's method only permits less than 10 Watt Seconds of Useful Electrical Energy.

"B". Given One Million Cycles per second at 100,000. Volts, using a 10 microfarad Capacitor.

Joules = [0.5 x .000,010 x 100,000. squared] x C.P.S.'s squared

[100,000 x 100,000. = 10,000,000,000.]

[.000,010 x 10,000,000,000. = 1,000]

[1,000 x 0.5 = 500]

[500 x One Million squared =]

The usefull Electrical Energy available is more than 500 Mega Joules [Watts] plus., Since the Resonate Electrons are nonimpacting, all the Energy is available for direct usage.

Benefits of the Inventors System are summarized:

1. Induction Energy transfer is enhanced by the squaring of the cycles second of the System.
2. Induction Energy transfer is enhanced by the squaring the input voltage.
3. Squaring of the flux lines occurs from the above, disturbing more electrons, therefore more electrical energy becomes available.
4. Resonate Induction has all the Electrons moving. unimpeded, resulting in superconductor conditions at room temperature.
5. A smaller amount of energy is used to disturb a larger number of Electrons. Electrons not originally a part of the System then contribute their energy, resulting in a net gain in available usable power.
6. The physical size of the System [Device] is small. The Device describe in "B" sits comfortable on a breakfast table.
7. A small energy source is used to start the device and remains fully charged at all times from the System .

Speech presented the evening of 23 July, 1994 at the
International Tesla Society Convention at Colorado Springs, Colorado

DONALD L. SMITH
ENERGY CONSULTANT
8110 BENT OAK LANE
SPRING, TEXAS 77379
(713) 370-4547, (713) 251-5114 Fax

ELECTRICAL ENERGY REFERENCE POINTS
Electrical Energy Generating System
Patent Pending # 08/100,074, 2/4/92

The word "electric" comes from the Latin word electron "amber". When rubbed, amber develops an electrical charge, which can be transferred to a dissimilar substance. During the seventeenth and eighteenth centuries, a great deal of attention was centered on this attribute of amber. Amber was used to differentiate the non-metals. Carbon-related substances and other non-metals, when subjected to friction, give up negative electrical charges. On the other hand, metals when subjected to friction, simply conduct the charge. It is important to note that approximately 70% of the Earth's exposed crustal portions (surface) consist of silicone related non-metals (electron donors) and therefore becomes a direct source of electrical energy when properly agitated.

Useful electrical energy is obtained by grounding into the Earth's non-metal crust and into its atmosphere as a natural source of electrons. These electrons have accumulated from the solar plasma during the aging of the Earth for more than 4.5 billion years, at a rate exceeding 3.9 exajoules per year. This indicates that the Earth's electrical field contains in excess of 17.6×10^{18} power of cumulative exajoules of energy. One Exajoule is the approximate energy equivalent of 125 million barrels of oil. The electrical energy in one display of lightning is approximately ten trillion joules. Each 24 hours, the land portions of the Earth's surface yields in excess of 200,000 emissions, which involves more than 2,000 quadrillion watt seconds of active energy on display.

ELECTRICAL ENERGY REFERENCE POINTS (Continued)

This physical phenomenon indicates the Earth's crust is an unending source of electrical energy. The surface area involved is a very small portion of the Earth's crust.

J.C. Maxwell (1891) suggested an active electron field gives rise to an associated magnetic field. Therefore, both are present with pulsating current. Early studies, involving observation of compass needles by microscopy, revealed that the needle vibrates as with alternating current. More recent studies by A. Nishida and others, confirm alternating current is common in the Earth's crust.

C.F. Gauss (1777-1855) and H.C. Oersted (1777-1851), both were separately trying to define the Earth's electrical field with external influences removed. These external influences being solar quiet periods and being remote from the land's surface. The air electricity background which which they measured varies with latitude. Their European measurements correspond to approximately the latitude of Washington, D.C. They were measuring magnetic field flux as an indicator of negative electron energy active and present.

A related family of measurement is now presented. Units of measure used to define flux fields include Gauss (one unit = 100,000 volts), Oersted (one unit = 50,000 volts), Tesla (one unit = 10,000 Gauss) and Gamma (one unit = 1/10,000 th of a Gauss). Much confusion exist in electrical related publications about these units. As presented here they are correct with values taken from their original definitions.

The entire surface of the Earth has been surveyed by aerial magnetometer, in most cases using gamma or nano teslas. One gamma is the magnetic flux equivalent of 10 active volts of electricity. When this data is corrected for flight height it becomes obvious that there are numerous areas where the gamma readings exceed one trillion gammas. Lightning strikes from the ground up are in that energy range. With knowledge of these electron enriched areas, the quality of Earth grounding, becomes enhanced.

ELECTRICAL ENERGY REFERENCE POINTS (Continued)

The correction necessary for land surface data when acquired from aerial magnetometer maps (using the inverse square law) requires that the remote distance be squared and then multiplied times the remote reading. As an example, the reading is 1,600 gammas and the flight height being 1,000 feet. Take $1,000 \times 1,000 = 1,000,000 \times 1,600$ gammas = 1.6 trillion gammas $\times 10$ volts = 16 trillion volts equivalent for land surface data.

INSERT AND DISCUSS, Aerial Magnetometer Map GP-948
East-Central United States

Present day methodology requires mechanical energy in exchange for electrical energy. Any required amount of electricity is available by resonate induction transfer from the Earth's magnetic and electrical fields. Each cycling of this resonate induction system pulls in additional electrons, generating energy in any required amount. A small amount of electrical energy is used to activate and pull into the system a much larger amount of energy.

ENERGY VERSES MASS

INSERT AND DISCUSS ELECTRICAL ENERGY

Steady State

Static "Pre-Energy "

Mass attracts Mass, Gravity
Dominates

Unsteady State

Kinetic "Energy"

Expanding, Magnetic Energy
Dominates

Electrons moving apart
Pressure decreasing
Cooling effect dominates
Less scattering of Energy
Negative resistance

Contraction, Electrical Energy
Dominates

Electrons moving together
Pressure increasing
Heating effect dominates
Scattering of Energy
Positive resistance

Functions of active Electrons

Electrons become active when placed inside the critical distance allowed by their negativity.

Active Electrons provide:

1. Electricity
2. Magnetics
3. Gravitational thrust as in Electric Motors
4. The source of Visible Light
5. It's charge is Negative

They move in a closed loop as seen in the Icon for infinity, not in a circle as shown in many books.

One half of the loop consist of a magnetic impulse and the return half consist of the electrical impulse. This is seen as the classic sine wave of alternating electrical energy.

A flash of light occures when two electrons suddenly find they are too close to gather. Daylight results from the impingement of Electrons in the Earth's atmosphere with the Electrons of the Solar Plasma.

My Concept of the Forces of Nature differs from the conventional. It consist of a weak and a strong force, each being additionally composed of electrical, magnetic and gravitational (fields & waves). Any two of the three constitute the third member. Gravity "B" of the weak force competes with humans on a daily basis. Gravity "A" of the strong force is the force that holds the Solar System and the Universe in place. Energy from the Electrons represent the weak force. Energy inside the Atom represents the strong force "A". Controlled resonate induction of any two of the three, changes into the third and is the motor that runs the Universe. We see this in the electrically induced magnetic thrust against gravity in electric motors.

Weak force is required to dislodge electrons and strong force (atomic) to dislodge protons.

Unless dislodged, these particles are of little value in producing Conventional Electrical Energy.

Memo

UNIQUE ASPECTS OF E.E.S. II

1. THE SYSTEM UTILIZES A FULLY RENEWABLE ENERGY SOURCE.
2. THE SYSTEM UTILIZES A NON POLLUTING ENERGY SOURCE.
3. THE SYSTEM UTILIZES AN UNIVERSALLY AVAILABLE ENERGY SOURCE.
4. THE SYSTEM IS SAFE. PARTS OF TESLA COIL SYSTEMS ARE LIFE THREATNING.
5. IT IS AN EXTENSION OF PRESENT TECHNOLOGY.
6. THE DISRUPTIVE DISCHARGE OF THE TESLA COIL IS ABSENT.
7. IT IS BASED ON THE MORE NEGATIVE TO LESS NEGATIVE CONCEPT.
8. ELECTRONS WHICH CYCLE THROUGH THE SYSTEM, AFTER BEING USED ARE RETURNED IN TACT TO THEIR FORMER STATE FOR FUTURE USAGE.
9. THE VOLT AMPERES REACTIVE CONCEPT APPLIES.
10. E.E.S. II IS LESS COMPLICATED THAN TESLA.
11. IT USES A DIFFERENT CONCEPT OF GROUNDING THAN TESLA.
12. THE PHYSICAL SYSTEM IS MUCH SMALLER THAN TESLA.
13. IT'S RATE OF ENERGY PRODUCTION AND EFFICIENCY IS MUCH HIGHER THAN TESLA.
14. EFFICIENCY OF INDUCTION RELATES TO THE SQUARE OF THE CYCLES PER SECOND. TESLA COILS OPERATE NORMALLY BELOW 200,000 C.P.S., IN THE 40,000 TO 50,000 C.P.S. RANGE. FOR A DIRECT COMPARISON SQUARE THE TESLA C.P.S. AND THEN THE MEGAHERTZ (100 PLUS) OF E.E.S. II . THE RATIO OF THE TWO DEMONSTRATES THE ACQUIRED IMPROVEMENT.
15. THE SYSTEM AND IT'S SOURCE UTILIZES MAGNETOMETER STUDIES.

E.E.S. II, BACKGROUND INFORMATION & CONCEPT

With alternating electrical current, electrons do not move from point "A" to point "B" as commonly envisioned! Electrical potential (oscillating electrons) at point "A" results in harmonic electron activity at point "B", when the grounding switch (circuit) is closed. That is to say, point "B" supplies it's own electrons and mirrors the activity of point "A". Impulsing (turbulence) by magnetic induction causes electrons to be pulled into the system, which then oscillates. When the magnetic field collapses (becomes absent) the electrical potential returns to it's natural background.

Several major flaws are present in the conventional 60 Hertz's per second method of electrical power generation and it's iron core transformer system. ***This system is handcuffed by the inverse relationship of volts to amperes.*** This represents a stodgy inflexible inheritance, courtesy of Mr. T.A. Edison and his concept of electrical power generation.

Nikola Tesla stood, almost alone, against Edison and managed to prevail with his alternating current system. Without the alternating current system, electronic things in the modern sense would not exist.

This report will be concerned with some of the extensions and benefits of the alternating current electrical system. ***This study will limit it's scope to air core coil transformers at radio frequency and upward. The electrical power produced by this method is inverted to direct current and then to alternating current as required for popular usage.*** There are several important advantages of this system over conventional power generation.

Start with two coils (separate-apart), one being a reactor coil (L-1) and a second coil (L-2), being the reactant coil. Magnetic field fluxing (off-on of the electrical source) causes inductive reactance of L-1 which replicates by induction in L-2. Pulsing of the magnetic field (from L-1) in the presence of L-2, generates electrical potential. For example, should the L-1 coil have ten turns, with an imposed A.C. potential of 1,200 volts. This results in each turn of L-1 acquiring 120 volts of potential. This induced magnetic field, then replicates itself in each turn of the L-2 coil. The L-2 coil may have one or many hundreds of turns. Modern encapsulation techniques makes high frequency and high energy controllable.

Let's take another important step in this air core transformer process. For purpose of discussion, let the value of inductive reactance at 60 Hertz's per second equal one. Each time the Hz's. are doubled, the effectiveness of induction is doubled. At about 20,000 Hz., ***when radio frequency is achieved, the electrons begin spinning free, outside of the inductor. They become increasingly free of the inverse relationship of volt-amperes.*** From this point on, they replicate by the inductive process as V.A.R.. ***That is to say, volts and amperes are equal, until resistance (work) is introduced.***

Therefore, additional, not previously available electrons become incorporated for a very large net gain in potential. This gain is real!

The quality of the grounding system determines the effectiveness of this method of producing electricity. A handy reference to locate the negative grounding areas for power generation can be found in the Aeromagnetic Map Studies of the US. Geological Survey. They provide an excellent method for locating the best sites for optimum negative grounding areas.

When this method is combined with the induction coil system, already described, it provides an electrical power generating system millions of times more efficient than any known conventional method.

This new system (E.E.S. II) is uncomplicated, small in physical size and inexpensive to build! All the technology required already exists. Maintenance is near zero, as there are no moving parts. Once operating, this system could last forever.

Small mobile E.E.S. II units are presently available as replacements for the batteries used in electric automobiles. Larger E.E.S. II units can be provided as a replacement source of power for hotels, office buildings, subdivisions, electric trains, manufacturing, heavy equipment, ships, and; generally speaking; in any present day application of electrical power.

Earth Electrical System II, Modular Units

The system consists of three separate modules. Reverse engineering is used in matching the modules to the desired usage.

HIGH VOLTAGE INDUCTION TRANSFORMER MODULE:

1. Preferably an off-the-shelf-unit similar to a TV flyback and/or automobile ignition type related coil (transformer).
2. Ratio of input to output may be from less than 1/100 to greater than 1/1,000. A voltage tripler may then be used.
3. A connection allowing the high voltage output to pass onward through the induction coil L-1 and then to it's grounding.

AN AIR CORE INDUCTION COIL TRANSFORMER MODULE:

1. Two coils, the reactor coil L-1 and the reactant coil L-2. L-1 has a high voltage radio frequency capacitor between it and it's grounding.
2. Input into the L-1 inductor is divided by the number of turns therein. The magnetic flux field provided from each turn of L-1 replicates itself as an electrical potential in each turn of L-2.
3. L-2 may have one turn or many hundreds of turns. The net gain depends upon the number of turns in L-2. Output from L-2 is in V.A.R. ***With this type of output, volts and amperes are the same until work(resistivity) is introduced.***

THE INVERTER MODULE:

1. Inverts to direct current (D.C.)
2. Inverts to alternating current (A.C.), as desired.
3. Provides customized output of electrical power ready for designated usage.

This system utilizes a non-polluting energy source.

Efficiency of induction relates to the square of the cycles per second. Compare the ratio of 60 cycles per second with the 200 million plus cycles per second for the system here presented.

Electrons which cycle through this System, after being used are returned in tact to their former state for future usage.

This System utilizes a fully renewable energy source.

This System utilizes a none poluting energy source.

OTHER LAW WITH CONNECTIONS:

A major connection is provided by the various forms of quantum energy in the universe. The Law of Conservation of Energy, Law of Conservation of Matter, and the Law of Conservation of Charge.

Volts = Energy / Charge (Potential)

Ohm = Resistance / Displacement of Energy (Load)

Amperes = The rate of displacement / scattering of energy

It is important to note that Ohm and Ampere are after the fact and are not directly related to the displacement factor. High Voltage is the energy source and displacement, but the High Voltage is not used for future usage. It is only the potential, determined by the quantum.

Functions of active Electrons (Continued)

INSERT AND DISCUSS:

1. Electrical Energy with Associated Phenomena
2. Energy Acquired by Magnetic and Electrical Impusing
3. Electrical Energy

Therefore, in conventional electrical energy production, the particle of importance is the negative electron. Electrons have a "grudging" relationship with other electrons. They like each other, especially at arms. length. Like potentials repel each other and unlike potentials attract. To demonstrate this, take two batteries of the same type, but of a different charge level (unequal potentials). Put the plus and minus ends facing the same direction. Then with a volt meter, measure the electrical potential between the two negative ends and then the two positive ends. It is obvious that the " more negative " moves to the " less negative ", is the correct concept for electrical energy generation. Electrical Energy flow consist of a higher concentration of electrons moving to an area of lesser concentration.

OHM'S LAW WITH CORRECTIONS:

A major obstruction in reference to the correct function of electrical energy is the establishment's incorrect interpretation of Ohm's Law. The corrected version is:

Volts = Energy Available (Potential)

Ohm = Scattering, dissipation of Energy (Load)

Ampere = the rate of, dissipation / scattering of energy

It is important to note that Ohm and Ampere are after the fact, and are not decisive except for the dissipation factor. High Voltage at low amperage simply means that the High Voltage is still intact for future usage. In no way is the potential diminished by low amperage.

EXAMPLES OF OVERUNITY

Dominos did not exist in England when the Laws of Conservation were originally put in place. Otherwise they might have been very different. For example let us take a long row of upright dominos, (many thousands) and flip number one. The Energy required to flip # 1 must now be added with that of thousands more in order to have a correct assessment.

The Electron it's self is an excellent example of overunity. The electron provides various forms of energy continuously throughout eternity and is in no way dimenished. It simply cycles through the system and is available thereafter.

In Electrical Systems, Electrons active at point "A" are not the same Electrons active at point "B". That is to say, the Electrons activated at the Central Electrical Energy Station are not the ones used at your house. When you ground your system by flipping the wall switch, you use your own electrons. In closed energy systems, electrons communicate with and and replicate the activity of the overbalanced potential, when provided with Earth and or Air Groundings.

The number of Radios and Televisions running at any one time do not diminish, in any way the electrical output of the source station.

For example, let now use use an Air Coil Resonate Induction System for the purpose of flipping some electrons.

The flipping device (reactor L-1 Coil) is pulsed which then provides a resonate induction pulse, in turn this flips the electrons present at the (reactant L-2) Coil. The energy input in L-1 is devided by the number of turns present. The induced magnetic pulsing in turn flips the electrons in each turn of L-2. If more turns are present in L-2 than L-1, there is a net gain in the Energy present, as demonstrated by the dominos above. The farads and henrys of the resonate system provide the resonate frequency when pulsed by an external energy system. A system shunt in the resonate circuit sets the containment level for energy potential.

EXAMPLES OF OVERUNITY (Continued)

The Induction Process it's self provides an excellent example of overunity. When comparing rate of induction the cycles per second must be squared and then compared to the square of the second System. Let's then compare the 60 c.p.s. System with my 220 Mhz. Device. Energy produced at radio frequency has several major advantages over the conventional system. Ohm's Law when applied to the resonate air core radio frequency system is not functional.

For example: When resonate the following is true.

EXPECTED RESULTS

$$\frac{\text{Energy Potential as Volts}}{\text{Dissipation}} = \text{Rate of Dissipation}$$

ACTUAL RESULTS

Super Conductor Conditions take over

$$\frac{\text{Energy Potential as Volts}}{(\text{Dissipation})^*} = (\text{Rate of Dissipation})^*$$

* OHMS / DISSIPATION, IN AIR COIL RESONATE INDUCTION SYSTEMS, RESISTIVITY BECOMES ZERO AT RESONANCE.

This is named the V.A.R. (Volt Amperes Reactive) System.

When compared to the Conventional Under Unity iron core transformer system, the results are over unity.

It is strange that mechanical advantage as in pulleys, gears, levers and others which correspond to the electrical advantage above mentioned are not considered over-unity devices.

EXAMPLES OF OVERUNITY DEVICES (Continued)

Let us take a closer look at resonate induction. As an example, let a room full of ping pong balls randomly bouncing at a high speed represent the Conventional method of underunity energy generation.

Suppose that by resonate induction the balls all move in the same direction at the same time. When this occurs a huge amount of energy not previously available is present. The resonate air core coil system lines up the electrons in such a manner that the energy factor is near 100 % , not 2 and 3 % as in Conventional underunity devices sanctioned by the establishment.

Some other devices where overunity is common would be resonate induction circuits present in conventional radio tubes (high plate voltage), negative feedback systems found in Op-Amps and possibly others.

SUMMARY

Useful electrical energy is achieved when the electron density at point "A" becomes greater than at point "B", (being the more negative moving to the less negative concept). Coils moving through a magnetic field or vice versa causes this imbalance.

The mind set of the professional electrical engineer is restricted to non-resonate and iron core coil resonate systems. Ohm's Law when applied to resonate air core induction systems, becomes, system resistivity (impedance, Z). " Z " at resonance becomes zero. Therefore, in this system, volts and amperes are equal until load (resistivity) is introduced. This is called the Volt Ampere Reactive (V.A.R.) System. With impedance being zero, the System grounding is coupled directly into the Earth's immense electrical potential.

Efficiency of induction relates to the square of the cycles per second. Compare the ratio of the conventional 60 c.p.s. System and the 220 million plus cycles of my Earth Electrical System II.

SUMMARY (Continued)

Electrons which cycle through this system, after being used, are returned in tact to their former state for future usage.

Electron spin causes electrical current and magnetic lines of force.

The effect of current results from the unequal distribution of negativity (electrons).

Magnetic imbalance causes the gravitational effect. This is evidenced in electric motors by magnet-gravitational displacement of mass which causes the motor to rotate.

The System is an extension of present technology

The System and it's source utilizes magnetometer studies.

This System (Earth Electrical System II, E.E.S. II) utilizes a fully renewable energy source.

This System utilizes a non-poluting energy source.

This System utilizes an universally available energy source.

Endorsement and Certification of The System can be anticipated by States with pollution problems.

Earth Electrical System I I

Information & Concept

Donald L. Smith

ENERGY CONSULTANT
8110 BENT OAK LN.
SPRING, TEXAS 77379
PH: (713)370-4547

ABSTRACT:

Earth Electrical System II, Power Generation

Useful electrical energy is achieved when the electron density at point "A" becomes greater than at point "B", (being the more negative moving to the less negative concept).

Coils moving through a magnetic field or vice versa causes this imbalance.

The mind set of the Professional Electrical Engineer is restricted to none resonate and iron core coil resonate systems. Ohm's Law when applied to resonate air core induction systems, becomes system resistivity (impedance, Z). " Z " at resonance becomes zero. Therefore, in this system, volts and amperes are equal until load (resistivity) is introduced. This is called the V.A.R. (Volt Amperes Reactive) System.

With Impedance being Zero, the System is then Coupled directly into the Earth's immense electrical potential.

ALTERNATING IMPACT ENERGY TRANSFER ANALOGY

ENERGY TRANSFER BY SWINGING
STEEL BALLS

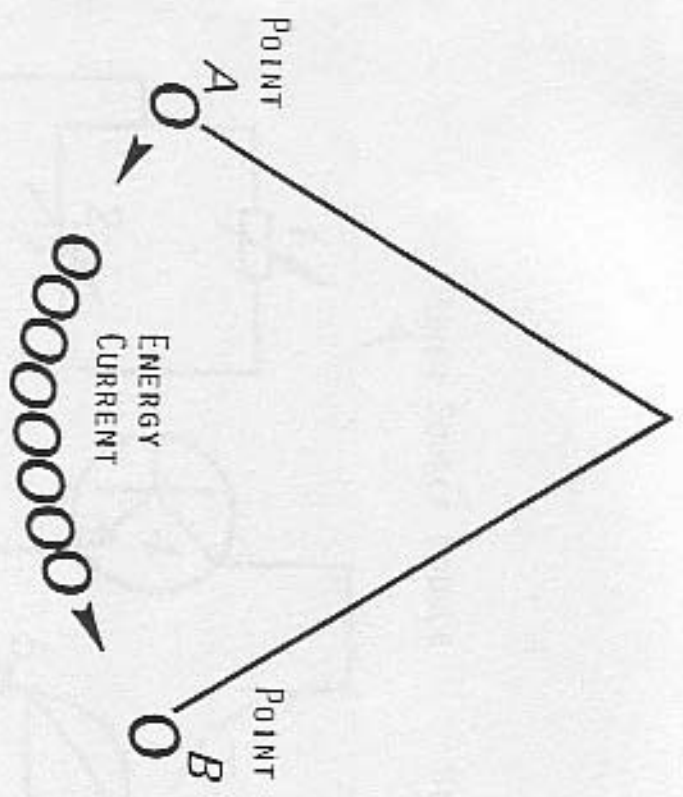

IN ALTERNATING ELECTRICAL ENERGY SYSTEMS, ONLY THE POTENTIAL-IMPACT LEVEL REPLICATES IT'S SELF AT POINT "B". ELECTRONS DO NOT TRAVEL FROM POINT "A" TO POINT "B".

ELECTRICAL ENERGY TRANSFER BY INDUCTION
PULSED (IMPACTED) ELECTRONS

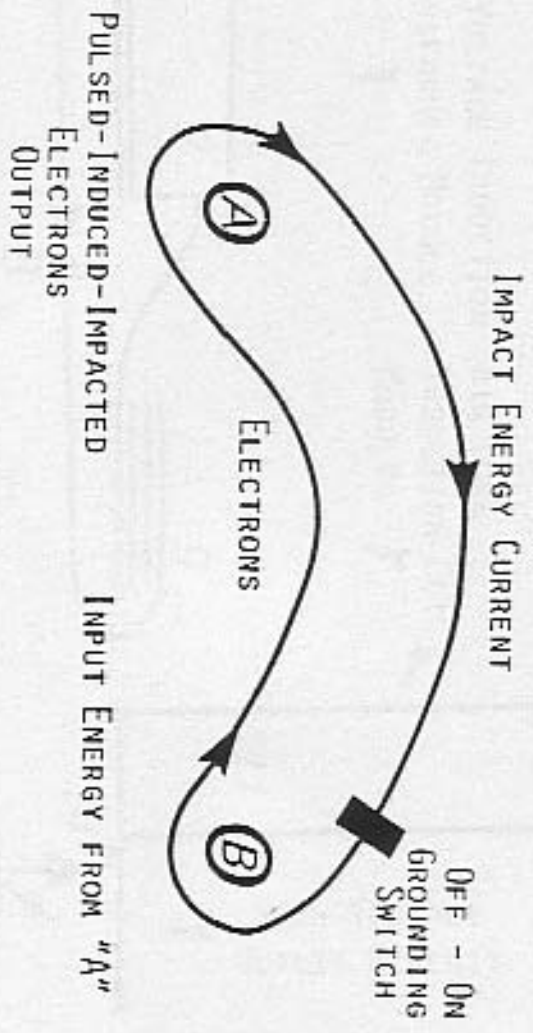

EARTH ELECTRICAL SYSTEM II, DOMESTIC USE RANGE MODULE
 UP TO TWO MILLION VOLT-AMPERES-REACTIVE OUTPUT *
 PLAN "A", WITH VARIABLE CONTROLS
 NOT TO SCALE

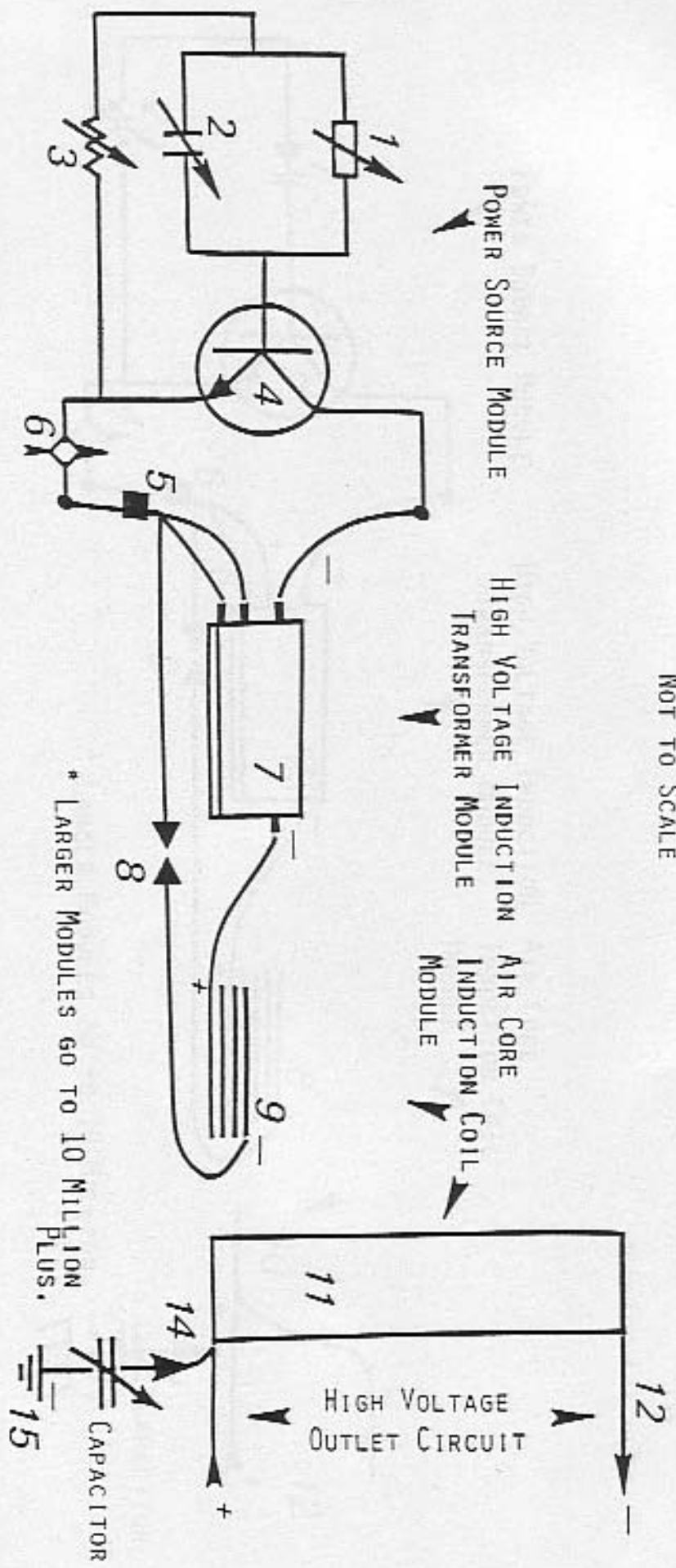

* LARGER MODULES GO TO 10 MILLION PLUS.

- PARTS: 1. COIL, VARIABLE, 2. CAPACITOR, VARIABLE, 3. RESISTOR, VARIABLE, 4. TRANSISTOR, R.F.,
 5. BATTERY, RECHARGEABLE, 6. OFF-ON SWITCH, VARIABLE, 7. HIGH VOLTAGE TRANSFORMER,
 8. FEED BACK WITH SPARK GAP, 9. REACTOR, INDUCTION COIL, 10. FEED BACK WITH SPARK GAP,
 11. REACTANT COIL, 12. OUTPUT FOR # 11, 13. INPUT FOR ELEVEN, 14. GROUNDING FOR ELEVEN,

EARTH ELECTRICAL SYSTEM II, DOMESTIC USE RANGE MODULE
 UP TO TWO MILLION VOLT-AMPERES-REACTIVE *
 PLAN "B", ELECTRICAL AUTOMOBILE ENERGY SOURCE

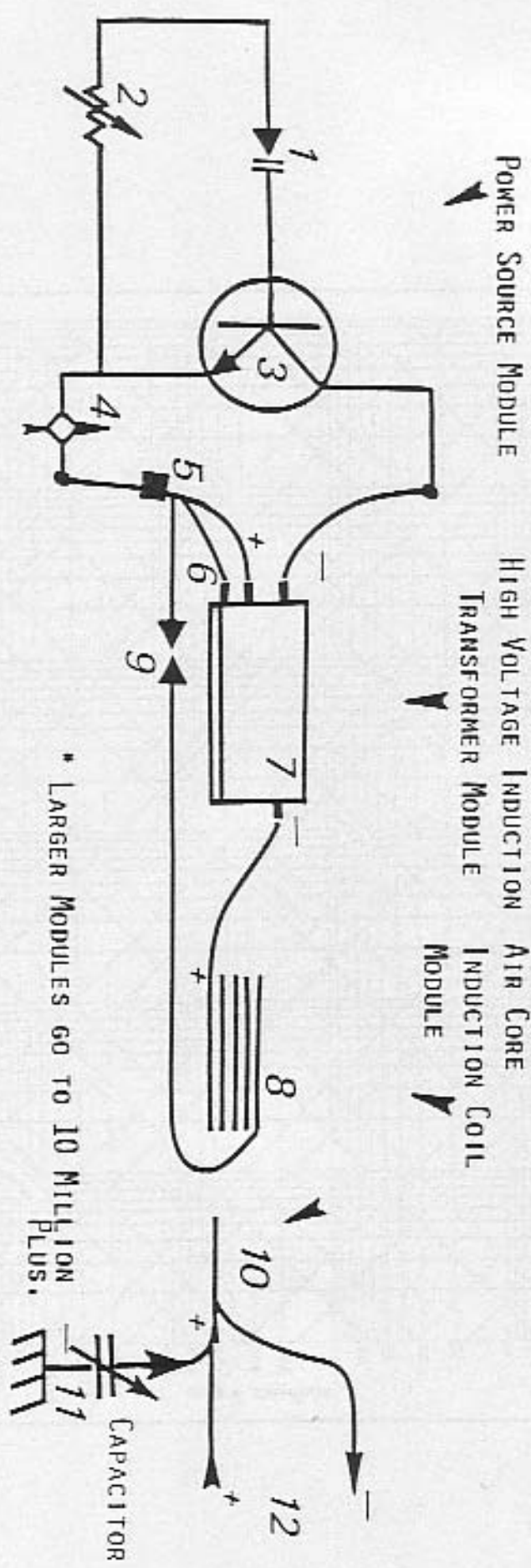

* LARGER MODULES GO TO 10 MILLION PLUS.

- PARTS: 1. VARACTOR, RADIO FREQUENCY, 2. RESISTOR, 3. TRANSISTOR, RADIO FREQUENCY,
 4. OFF-ON SWITCH, MULTI-POSITION, 5. BATTERY, RECHARGEABLE, 6. TRANSFORMER GROUNDING,
 7. HIGH VOLTAGE INDUCTION TRANSFORMER, 8. REACTOR, INDUCTION COIL, 9. FEED BACK WITH
 SPARK GAP, 10. REACTANT, INDUCTION COIL, 11. GROUNDING FOR # 10, OUT-PUT CIRCUIT,
 IN VOLT-AMPERES-REACTIVE.

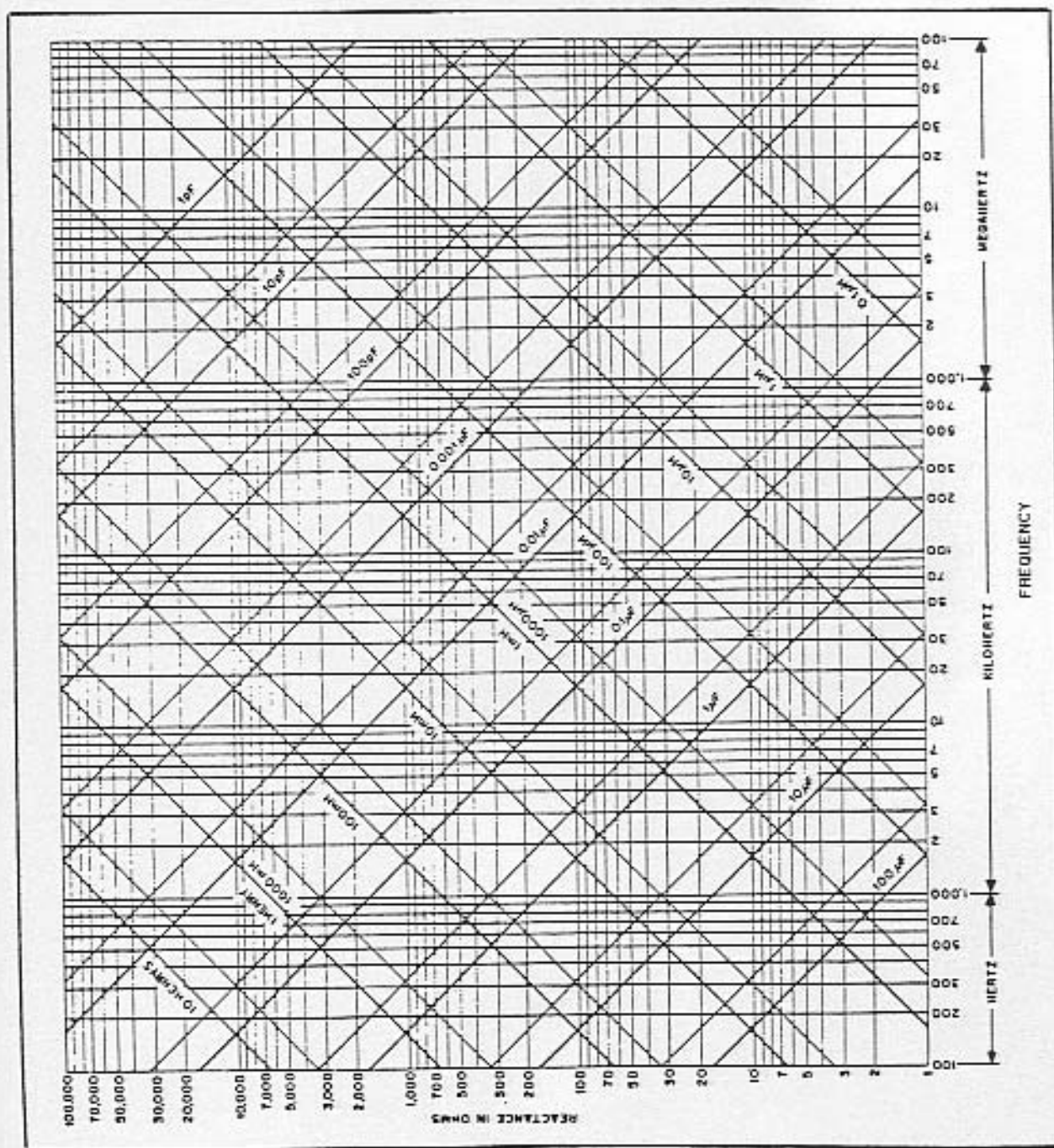

FIG. 44 — Inductive and capacitive reactance vs. frequency. Heavy lines represent multiples of 10. Intermediate light lines multiples of 10. For example, the light line between 10 μH and 100 μH represents 50 μH ; the light line between 0.1 μF and 1 μF represents 0.5 μF , and so on. Intermediate values can be values within the chart range. For example, the reactance of 10 henrys at 60 Hz can be found by taking the reactance of 10 henrys at 600 Hz and dividing by 10 for the 10 x times decrease in frequency.

AIR CORE INDUCTION COIL BUILDERS GUIDE

DONALD L. SMITH

Energy Consultant

NOTES

AIR CORE INDUCTION COIL BUILDERS GUIDE

DONALD L. SMITH

Energy Consultant

1. Decide frequency. Considerations are: (economy of size)
 - a. Use radio frequency upward (above 20,000 Hz's).
 - b. Use natural frequency (coils have both capacitance and inductance), that is match the wire length of the wire in the coil to the desired frequency.
 - c. Wire length is either one quarter, one half or full wave length.
 - d. obtain wire length (in feet) use the following: If using one quarter wave length divide 247 by the desired frequency (megahertz range is desirable). If using one half wave length divide 494 by the desired frequency. If using full wave length divide 998 by the desired frequency.
2. Decide number of turns, ratio of increase in number of turns sets the function. In the case of L-1 coil each turn divides the input voltage by the number of turns. In the case of L-2 the resulting voltage by division from L-1 is induced into each turn of L-2, resulting in an additive process. For example if the input into L-1 from a high voltage, low amperage module is 2,400 volts. L-1, for example has 10 turns. Then each turn of L-1 will have 240 volts of magnetic induction which transfers 240 volts of electricity to each turn of L-2. L-2 may be one turn or many, such as 100 to 500 plus turns. At 100 turns, 24,000 volts is produced. At 500 turns, 120,000 volts is produced.
3. Decide the height and diameter of the coil system. The larger the diameter of the coil, the fewer number of turns required, and shorter (lowering of) in height. In the case of L-2 this results in lowering the amplification of the induced voltage from L-1.
4. For example, 24.7 MHz is the desired frequency output from L-2. One quarter wave length would be 247 divided by 24.7 equals 10 feet of wire. The number of turns will be the amplification factor. The coil may be wound on standard size P.V.C. or purchased from a supplier. The supplier is normally a ham radio supply source. Once the length is determined and the number of turns decided, move the next step. For example let each turn of L-1 have 24 volts and desired output of L-2 being 640 volts. Therefore L-2 needs 26.67 turns. It has been determined that the wire length for one quarter wave length is 10 feet. The number of inches in 10 feet is 120. Using Chart "A" supplied look for next higher number of turns showing (being between 20 and 30 turns with a 2" diameter coil). This tells us

to use a 2" coil. If ready made as in the case of Barker and Williamson, 10 Canal Street, Bristol, Penna., 215-788-5581, they come in standard sizes of 4, 6 and 10 turns per inch. For higher "Q" use wider spacing of the turns. These coils come in a ready made length of 10 inches. Select from the coil 30 turns and put input clamps on the base of the coil and at 30 turns. For exact determination of the correct position of the output clamp, use an externally grounded voltage probe. The node of maximum intensity, being the natural resonate point. Off the shelf multimeters are not radio frequency responsive. The easiest way to accomplish the above is to get from the hardware store or Radio Shack a voltage detector having a neon bulb system (Radio Shack Cat. No. 272-1100b, NE2-Neon Lamps) will work. With your hand as a ground, move the wire extension of the neon lamp along the coil surface until bulb is brightest. This is the desired point of resonance and connection.

5. The input power now needs consideration. A 2,400 H.V. module has been previously selected. This module can be made from a diode bridge or any combination of voltage amplifiers. The one used here is an off-the-shelf type, similar to those used for laser technology.
6. Construction of the input L-1 coil. For purposes already determined there will be 10 turns. Length of the wire here is not critical. Since L-2 is 2" in diameter, the next off-the-shelf larger may be used for L-1. Use a 3" diameter off the shelf coil having 10 turns to the inch. Remove (cut) a 10 turn portion from the larger coil. Use a L.C.R. meter and get the natural farads and henry's reading from L-2. Now do the same for L-1. It will be necessary to put a capacitor for matching L-1 to L-2 across the voltage input of L-1. Also a spark gap in parallel is required on the return voltage from L-1. A tunable capacitor of the pad type for L-1 is desirable.
7. L-2 can be further enhance by having an Earth grounding from the base of the coil. The maximum voltage output will be between the base and top of L-2. Lesser voltage can be obtained at intermediate points from L-2.

SUPPLY SOURCES

1. HAM RADIO SUPPLY STORES
2. COILS, AIR INDUCTOR IN HOUSTON

BAKER AND WILLIAMSON (READY MADE), BRISTOL, PENNA.
ALSO R.F. DUMMY LOADS AND WATTMETERS.

ELECTRICAL PRINCIPLES, TERMINOLOGY & SAFETY

The use of electricity is so common place that most people assume that it will always be available on demand. To fully realize the dependence upon electricity, survey the ways electricity is being used each day in the home and on the farm and ranch. Electricity is doing more to increase work efficiency and promote enjoyable living than any other single factor. The use of electricity has grown to the extent that an increasing portion of the home or business budget is used in paying for this source of energy.

1. Definition of Electricity

Electricity can be defined in several ways. The layman defines electricity as a source of energy that can be converted to light, heat, or power. Electrical engineers define electricity as a movement of electrons caused by electrical pressure or voltage. The amount of energy produced depends on the number of electrons in motion.

2. The Manufacture and Distribution of Electricity

Electricity is produced from generators that are run by water, steam, or internal combustion engines. If water is used as a source of power to turn generators, it is referred to as hydroelectric generation. There are a number of this type located in areas where huge dams have been built across large streams.

Steam is used as a source of power for generating much of today's electricity. Water is heated to a high temperature, and the steam pressure is used to turn turbines which generate electricity. These are referred to as thermal-powered generators. Fuels used to heat the water are coal, natural gas, and/or fuel oil.

Generators at the power plant generate from 13,800 to 22,000 volts of electricity. From the power plant, electricity is carried to a step-up substation which, through the use of transformers, increases the voltage from 69,000 to 750,000 volts. This increase in voltage is necessary for the efficient transmission of electricity over long distances. From the step-up substation, the electricity is carried on transmission lines to a step-down substation which reduces the voltage to 7,200 to 14,000 volts for distribution to rural and city areas.

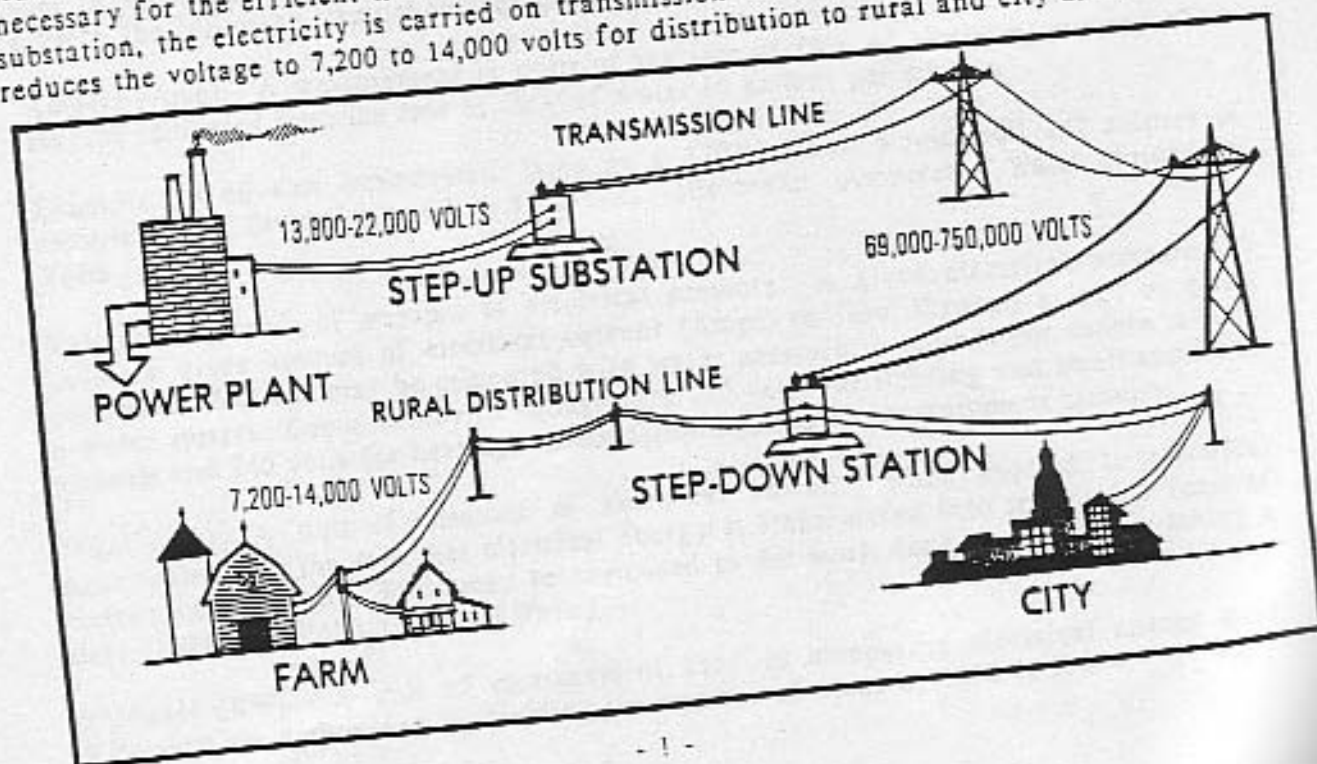

Transformers at the business or residence reduce the voltage to 120 or 240 volts to the meter of the customer.

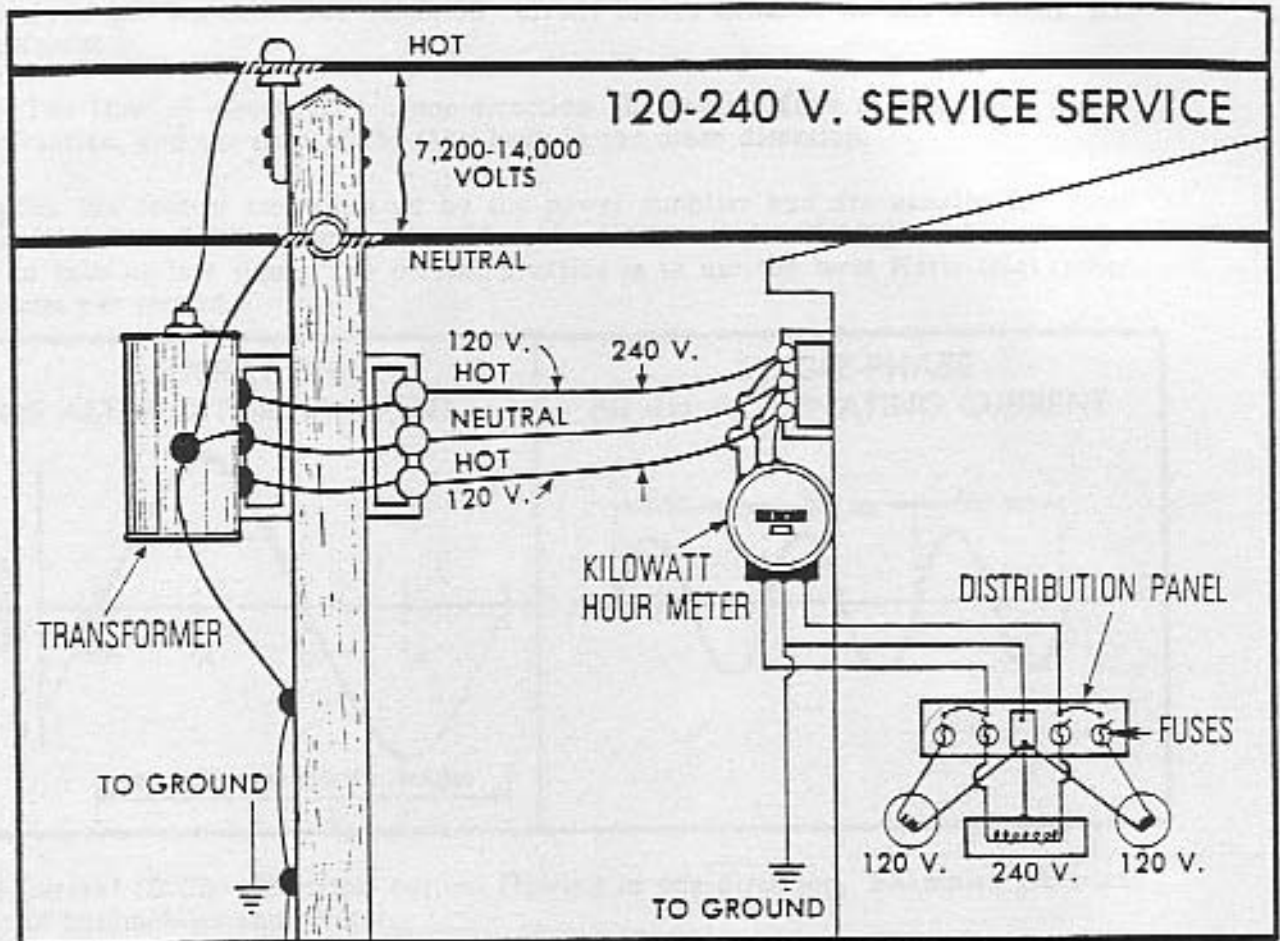

3. Common Electrical Terms

In order to work safely and efficiently with electricity and have the ability to converse on the subject, the following terms should be understood:

Ampere (Amp) - A measurement in units of the rate of flow of electrical current. This may be compared with the rate of flow of water in gallons per minute.

Example: A 60-watt incandescent lamp on a 120V circuit would pull 1/2 ampere of electricity (60 divided by 120 = .5 or 1/2). (Formula: Amperes = Watts divided by Volts)

Volt (V) - A unit of measure of electrical pressure. A given electrical pressure (V) causes a given amount of electrical current (Amps) to flow through a load of given resistance. Voltage may be compared with water pressure in pounds per square inch in a water system. Common service voltages are 120 volts for lighting and small appliance circuits and 240 volts for heating, air conditioning, and large equipment circuits.

Watt (W) - A unit of measure of electrical power. When applied to electrical equipment, it is the rate that electrical energy is transformed into some other form of energy such as light. Watts may be compared to the work done by water in washing a car. (Formula: Volts x Amps = Watts)

Kilowatt (KW) - A unit of measurement used in computing electrical energy used. Kilowatts are determined by dividing the number of watts by 1000 (1 KW = 1000 W).

Kilowatt Hour (KWH) - A measure of electricity in terms of power in kilowatts and time in hours. A KWH is 1000 watts used for one hour.

Alternating Current (A.C.) - Electrical current that alternates or changes direction several times per second. The direction current moves depends on the direction the voltage forces it.

Cycle - The flow of electricity in one direction, the reverse flow of electricity in the other direction, and the start of the flow back in the other direction.

The cycles per second are regulated by the power supplier and are usually 60. Most electric clocks are built to operate on 60 cycles. More or less cycles would cause the clocks to gain or lose time. The present practice is to use the term Hertz (Hz) rather than cycles per second.

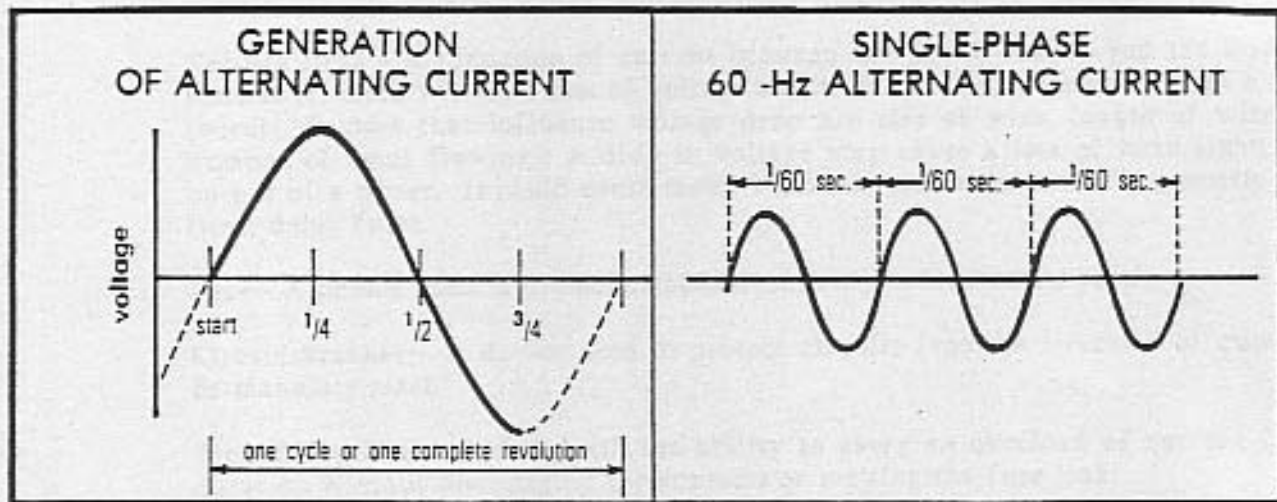

Direct Current (D.C.) - Electrical current flowing in one direction. Example: electrical circuit in automobiles and tractors.

Transformer - A device used to increase or decrease voltage.

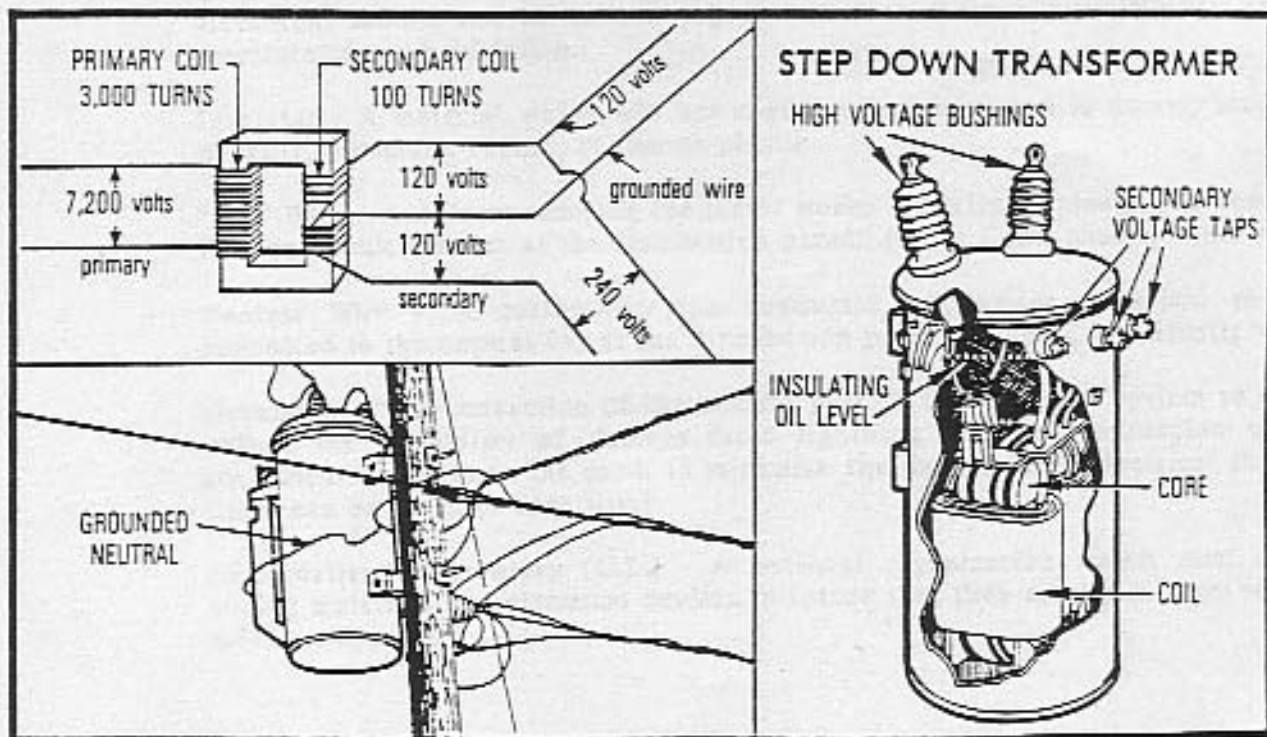

Single Phase - The most common type of electrical service or power available to consumers. One transformer is used between the distribution line and the meter. Usually three wires, two "hot" and one neutral, are installed to provide 120V and 240V single-phase service. Single-phase service may also be supplied with three-phase service.

Three-Phase - This type of service is designed especially for large electrical loads. It is a more expensive installation due to three wires and three transformers. The important advantage of three-phase power is that the total electrical load is divided among the three phases; consequently, the wire and transformers can be smaller. Other advantages exist in the design of three-phase motors.

Short Circuit - A direct connection (before current flows through an appliance) between two "hot" wires, between a "hot" and neutral wire, or between a "hot" wire and ground.

Voltage Drop - A reduction of current between the power supply and the load. Due to resistance, there will be a loss of voltage any time electricity flows through a conductor (wire). Factors that influence voltage drop are size of wire, length of wire, and the number of amps flowing. A drop in voltage may cause a loss of heat, light, or power output of a motor. It could cause motor burn-out unless the motor is properly protected (time-delay fuse).

Fuse - A device used to protect circuits from an overload of current.

Circuit Breaker - A device used to protect circuits from an overload of current. May be manually reset.

Time-Delay Fuse - A fuse with the ability to carry an overload of current for a short duration without disengaging the contacts or melting the fuse link.

Horsepower (hp) - A unit of mechanical power equal to 746 watts of electrical power (assuming 74.6% electric motor efficiency). One hp and above motors are rated at 1000 watts per hp; motors below one hp are rated at 1200 watts per hp.

Conductor - The wire used to carry electricity (copper or aluminum). Copper and aluminum should not be spliced together due to their incompatibility resulting in deterioration and oxidation.

Insulator - A material which will not conduct electricity and is usually made of glass, bakelite, porcelain, rubber, or thermo-plastic.

"Hot" Wire - A current-carrying conductor under electrical pressure and connected to a fuse or circuit breaker at the distribution panel. (Color Code: usually black or red)

Neutral Wire - A current-carrying conductor not under electrical pressure and connected to the neutral bar at the distribution panel. (Color Code: usually white)

Grounding - The connection of the neutral part of the electrical system to the earth to reduce the possibility of damage from lightning and the connection of electrical equipment housings to the earth to minimize the danger from electrical shock. (Color Code: can be green or bare wire)

Underwriters' Laboratory (U.L.) - A national organization which tests all types of wiring materials and electrical devices to insure that they meet minimum standards for safety and quality.

National Electric Code (N.E.C.) - Regulations approved by the National Board of Fire Underwriters primarily for safety in electrical wiring installations. All wiring should meet the requirements of the national as well as the local code.

4. Computing Electrical Energy Use and Cost

If an estimate of cost for electricity used is desired, the name plate data on appliances and equipment and an estimate of operating time may be used. The following formulas should be used for determining watts, amps, volts, watt-hours, kilowatt-hours, and cost.

$$\text{WATTS} = \text{VOLTS} \times \text{AMPERES}$$

$$\text{AMPERES} = \frac{\text{WATTS}}{\text{VOLTS}}$$

$$\text{VOLTS} = \frac{\text{WATTS}}{\text{AMPERES}}$$

$$\text{WATTS} \times \text{HOURS OF OPERATION} = \text{WATT HOURS}$$

$$\text{KILOWATT-HOURS} = \frac{\text{WATT-HOURS}}{1000}$$

$$\text{COST} = \text{KWH} \times \text{LOCAL RATE PER KWH}$$

EXAMPLE COST PROBLEM:

LOCAL RATE PER KWH USED - 8 CENTS
 NAME PLATE DATA - 120 VOLTS, 5 AMPS
 MONTHLY HOURS OF OPERATION - 10

$$(1) (W = V \times A) \quad W = 120 \times 5 \quad W = 600$$

$$(2) (\text{WATT-HOURS} = W \times \text{HOURS}) \quad \text{WATT-HOURS} = 600 \times 10 \quad \text{WATT-HOURS} = 6000$$

$$(3) (\text{KWH} = \frac{\text{WATT-HOURS}}{1000}) \quad \text{KWH} = \frac{6000}{1000} \quad \text{KWH} = 6$$

$$(4) (\text{COST} = \text{KWH} \times \text{RATE}) \quad \text{COST} = 6 \times 8 \quad \text{COST} = 48 \text{ CENTS}$$

5. Electrical Circuits

An electrical circuit is a completed path through which electricity flows. Insulated conductors (wires) provide the path for the flow of electricity. A water system and an electrical circuit are similar in many respects. Water flows through pipes and is measured in gallons per minute, and electricity flows through conductors and is measured in amperes. A simple circuit is diagrammed here:

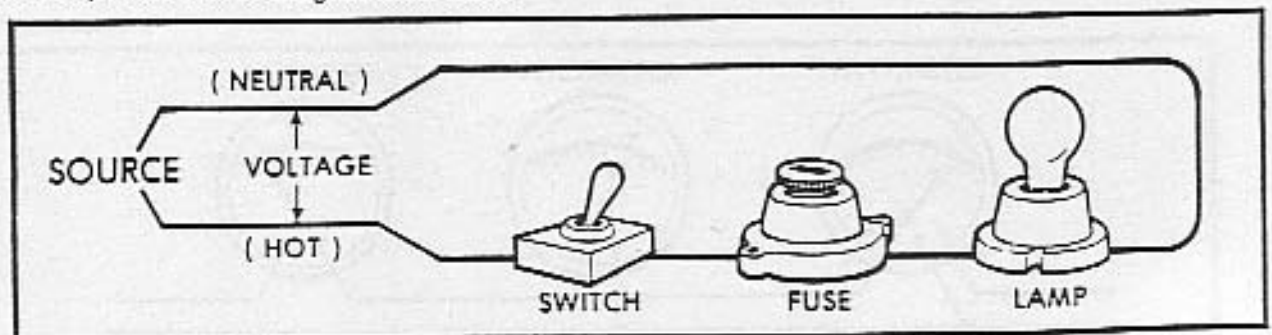

A circuit includes a "hot" wire (red or black) carrying current from the source through a switch, circuit protector (fuse or circuit breaker), and an appliance. The neutral wire (white) conducts the current from the appliance to the source (ground).

There are two methods for connecting devices in a circuit--series and parallel. In a series circuit all the current must flow through each device in the circuit. Removing or opening any one of the devices in the series circuit will stop the flow of current. In parallel circuits the load (lights or appliances) are connected between the two wires of the circuit providing an independent path for the flow of current, and removing a lamp has no effect on the other lamps in the circuit.

Switches, fuses, and circuit breakers are always connected in series. In most cases, except for some Christmas tree lights, appliances and lights are connected in parallel.

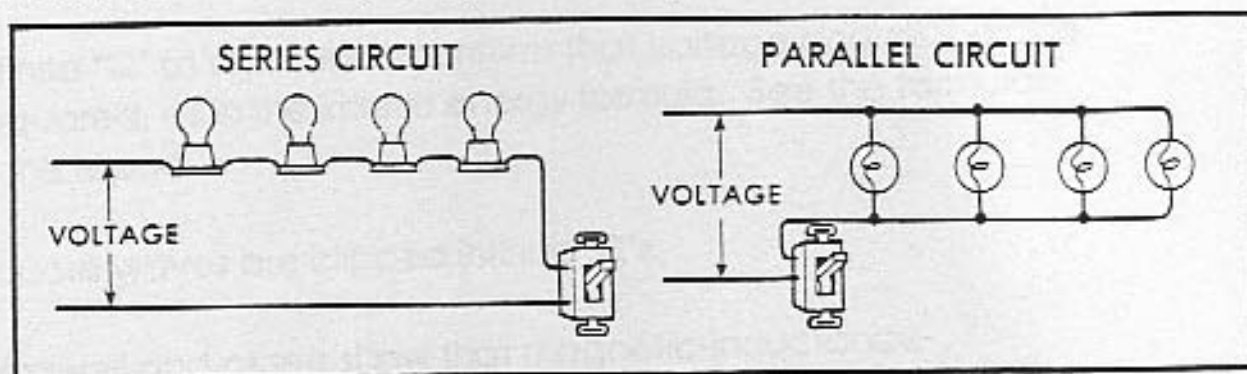

6. 120 Volt and 240 Volt Circuits

The 120V circuit has one "hot" and one neutral wire with the switch and circuit protector in the hot line. The neutral wire from the appliance is connected to the neutral bar in the fuse or breaker box. For safety, the neutral wire should never be broken or interrupted with a switch or fuse.

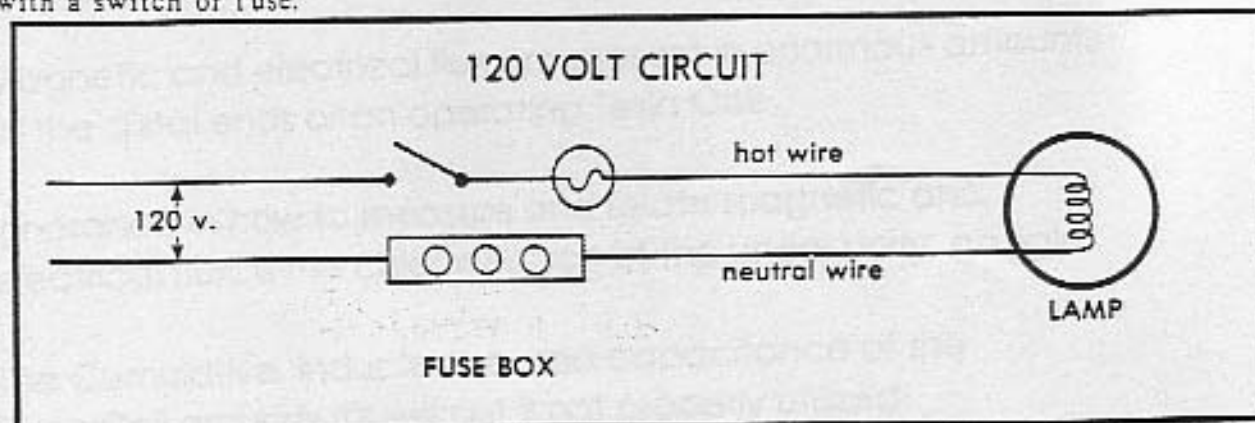

The voltage in a 120V circuit is measured with a voltmeter with one lead on the hot terminal and the other lead on the neutral bar. The number of amperes flowing may be measured with a clamp-on ammeter by encircling the hot or neutral wire with the jaws of the ammeter.

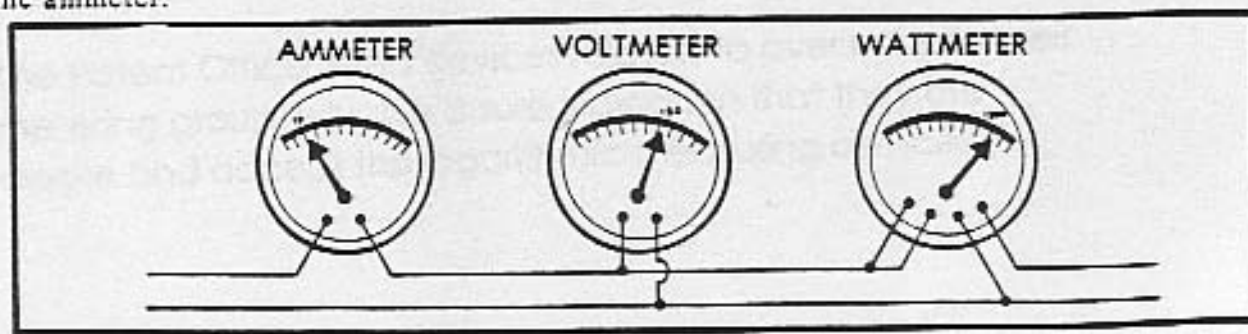

The Evidence Against Under Unity

1. Use of Logarithmic Scales on electrical measurement instruments. Linear measurement works fine where Ohm's Law applies (direct current). In alternating current ohms are replaced by impedance and the measurements become non linear.
2. Infinite "Q" at resonance confirms that voltage and amperage is squared, as in the kinetic energy formula. See the formulas of this report.
3. Square waves are clipped infinite "Q"s.
4. Maxwell and others show that magnetic-inductance-amperage and electrical-capacitance-voltage are two sides of the same coin, Magnetic-inductance is directly equal to amperage. Both obey the Law of Squares, which has over unity built in.
5. Magnetic and electrical flux are present in enormous amounts at the distal ends of an operating Tesla Coil.
6. Ignorance in how to measure and relate magnetic and electrical flux, is the chief weapon of the under unity gaggle.
7. The Cumulative inductance and capacitance of the Tesla Coil grounds it's self out if not properly utilized. See this report for the temporary energy storage accessible, if properly managed.
8. The Patent Office refers devices related to over unity to their metering group, which is a sure indication that they are aware and accept the logarithmic measuring devices.

This is direct and absolute evidence that they accept the square law as relates to kinetic energy. This also indicates they are aware that over unity exist. Since their bureaucratic brain is improperly motivated they continue to badger inventors who are working in the over unity arena. Their level of intellectual dishonesty is sanctioned by, and is a real part of doing business with a government which prides it's self in being a hooliganistic bureaucracy.

Reading List

1. Alston, L.L. (Ed.), 1968, High-Voltage Technology, Oxford Univ. Press, London.
2. Beck, E. 1954, Lightning Protection for Electric Systems, McGraw-Hill, N.Y.
3. Bowdler, G.W. 1973, Measurements in High-voltage Test Circuits Pergamom, Oxford. L.C. 72-86488
4. Brewley, L.V., 1951, Traveling Waves in Transmission Lines Pub: John Wiley, N.Y.
5. Chapman, S. and Bartels, J., 1940, Geomagnetism, two volumes, 1,000 plus pages, Oxford at the Clarendon press, England
6. Craggs, J.D. and Meek, J.M. 1954, High-Voltage Laboratory Technique., Butterworth, London
7. EHV Transmission Line Reference Book, 1968 Edison Electric Institute, N.Y.
8. Farno, R.M., Chu, L.J., and Adler, R.B., 1968, Electromagnetic Fields, Energy and Forces, Pub: M.I.T Press, Cambridge, Mass.
9. Feinberg, R. (Ed.) 1979, Modern Power Transformer Practice, McMillan, London
10. Frungel, F., High Speed Pulse Technology, Vols. 1 and 2, Pub: Academic Press, 1965, N.Y., and London.
11. Gallagher, T.J. and Pearmain, A.J. 1983, ISBN 0-471-90096-6 High Voltage Measurement and Design, John Wiley, N.Y.
12. Hague, B., Alternating-Current Bridge Methods, 5 th. ed. Pub: Sir Iasaac Pitman and Sons, 1959, London.
13. Hawley, W.G. 1959, Impulse-voltage Testing, Chapman and Hill, London.
14. Hayashi, Ch., Nonlinear Oscillations in Physical Systems, Pub: McGraw-Hill, 1964, N.Y.
15. Henny, K. 1933-1959, Editor-in-Chief, Radio Engineering Handbook, five different copyrights, L.C. 58-11174, McGraw Hill, N.Y.
16. Hudlestone, R.H. and Leonard, S.L., Plasma Diagnostics Techniques, Pub: Academic Press, N.Y.
17. Jacobs, J.A., Editor, Geomagnetism, (a massive work) 3 large volumes, Pub: Academic Press, London.
18. Jeans, J.H. 1925, The Mathematics of Electricity and Magnetism, 5 th. Ed., Chambridge University Press,
19. Jones, B. 1972, New Approaches to the Design and Economics of EHV Transmission Plant, Pergamom, London.
20. Kind, D. 1978, An Introduction to High-voltage Experimental Technique, Viewieg, Braunschweig ISBN 3-528-08383-2
21. Knoepfel, H. 1970, Pulsed High Magnetic Fields, North-Holland, Amsterdam.
22. Kreuger, F.H. 1964, Discharge Detection in High-Voltage Equipment, Temple Press, Heywood, London.
23. Kuffel, E. and Zaengl, W.S. 1984, High-Voltage Engineering, Pergamom, ;London. ISBN 0-08-024213-8
24. Kupfmuller, K. 1957, Introduction to the Scientific Basis of Electrical Engineering, Pub: Spinger, Berlin.

25. Lemon, H.B. and Ference, M. Jr., Analytical Experimental Physics " a major work " from The Ryerson Physical Laboratory at the University of Chicago, numerous copyrights 1933-1944. Printed as a text book by the University of Chicago Press
26. Lewis, I.A.D., and Well, F.H., Millimicrosecond Pulse Techniques Pub: Pergamon Press, N.Y. and London.
27. Malan, D.J. 1963, Physics of Lightning, English University Press, London.
28. Martin, T.L. Jr., Physical Basis for Electrical Engineering, Prentice-Hall, N.J.
29. Matsusta, S. and Campbell, W.H., 1967 Physics of Geomagnetic Phenomena, Massive work in two volumes of 700 pages each, Academic Press, London.
30. National Physical Laboratory, 1956, Notes on Applied Science # 17, High Voltage Impulse Testing, HMSO.
31. Rather, H., 1961, The Electron Avalanche and it's Generation, Pub: Vo. 33, Springer, Berlin.
32. Rokityansky, I.I., 1982, Geoelectromagnetic Investigation of the Earth's Crust and Mantle, Pub: Springer-Verlag, Berlin.
33. Salge, J., Peier, D., Brilka, R., Schneider, D., 1970, Applications of Inductive Energy Storage for the Production of Intense Magnetic Fields, Pub: Proceedure of 6 th. Symp. on Fusion Technology, Aachen.
34. Schulz, E.H., Anderson, L.T., and Leger, R.M., Experiments in Electronics and Communication Engineering, Copyrights, various, from 1943 thru 1954 LC 55-5033 Harper and Brothers, N.Y.
35. Schwab, A.J. 1972, High-Voltage Measurement Techniques, The M.I.T. Press, Cambridge, Mass., ISBN 0262-19096-6
36. Sevin, L., 1965, Field Effect Transistors, McGraw-Hill, London.
37. Silsbee, F.B., 1942, Static Electricity, U.S. Department of Commerce, Washington, D.C., U.S. Government Printing Office, (N.B.S. Circular C 438)
38. Smith, A.A., 1977, Coupling of External Electromagnetic Fields to Transmission Lines, ISBN 0-471-01995-X
39. Terman, F.E., Electronics and Radio Engineering, 4 th. ed., Copyrights 1932, 1937, 1947 and 1955 LC 55-6174 McGraw-Hill Book Co., N.Y.
40. Thomas, R.T., 1970, High-Impulse Current and Voltage Measurement, Trans. I.E.E.E. IM-19, pages 102-107
41. Thompson, Professor W., (titled Lord Kelvin) Reprint of Papers on Electrostatics and Magnetism (original 1872) London.
42. Traister, R., 1983, The Experimenter's Guide to Solid State Diodes, Prentice-Hall, Inc. ISBN 0-13-295444
43. Valley, G.E., and Wallman, H., 1948, Vacuum Tube Amplifiers, McGraw-Hill, N.Y.
44. Weedy, B.M. 1980, Underground Transmission of Electrical Power, Wiley, London.
45. Weeks, W.L. 1981, Transmission and Distrubution of Electrical Energy, Harper and Row, N.Y.
46. Winch, R.P. Electricity and Magnetism (several printings) Composed in Copenhagen, Denmark, Prentice-Hall Physics Series
47. Zijlstra, H., 1957, Experimental Methods in Magnetism, two volumes, North-Holland Publishing Co., Amsterdam.

An Answer to America's Energy Deficit

Donald L. Smith
Energy Consultant

Energy, energy everywhere and not a Joule to Jounce. Conventional wisdom, when properly tuned will appreciate the nature of energy, as here presented. The basic unit of electricity (the electron) upon encountering a moving magnetic field (or wave) spins, giving off an electric impulse. When this impulse collapses, it spins back to it's natural position, giving off a magnetic impulse. Therefore, magnetic and electric are two sides of the same coin. When the magnetic side is pulsed, it yields electricity and conversely, pulsing of the electrical side yields a magnetic field. Moving one in relation to the other produces useful energy. When done consecutively, each cycle pushes (current) forward, while pulling electrons into the system...in much the same way as a water pump moves water. These electrons are obtained from Earth and air grounding.

The word "electric" comes from the Latin word electron "amber". When rubbed, amber develops an electrical charge, which can be transferred to a dissimilar substance. During the seventeenth and eighteenth centuries, a great deal of attention was centered on this attribute of amber. Amber was used to differentiate the non-metals. Carbon-related substances and other non-metals, when subjected to friction, give up negative electrical charges. On the other hand, metals when subjected to friction, simply conduct the charge. It is important to note approximately 70% of the Earth's exposed crustal portions (surface) consist of silicone related non-metals (electron donors) and become a direct source of electrical energy when properly agitated.

Useful electrical energy can be obtained by grounding into the Earth's non-metal crust and into it's atmosphere as a natural source of electrons. These electrons have accumulated from the solar plasma during the aging of the Earth for more than 4.5 billion years, at a rate exceeding 3.9 exajoules per year. This indicates that the Earth's electrical field contains in excess of 17.6×10^{18} cumulative exajoules of energy. One Exajoule is the approximate energy equivalent of 125 million barrels of oil. The electrical energy in one display of lightning is approximately ten trillion joules. Each 24 hours, the land portions of Earth's surface yields in excess of 200,000 emissions, which involves more than 2,000 quadrillion watt

seconds of active energy in the display. This physical phenomenon indicates the Earth's crust is an unending source of electrical energy. The surface area involved is a very small portion of the Earth's crust.

J.C. Maxwell (1891) suggested an active electron field gives rise to an associated magnetic field. Therefore, both are present with pulsating current. Early studies, involving observations of compass needles by microscopy, revealed the needle vibrates as with alternating current. More recent studies by A. Nishida and others, confirm alternating current is common in the Earth's crust.

In the early 1700's Benjamin Franklin demonstrated electricity flows from one point to another. This report by Franklin set forth the concept of positive and negative charges. The electron (negative) charge is the one which moves to the positive area where it is balanced out by the proton (positive) charge. This concept is flawed in several respects. The author's concept of the forces of nature differs from conventional. The concept is that of weak force and strong force, each being additionally composed of electrical, magnetic and gravitational (fields & waves). Any two of the three constitute the third member. Gravity "B" of the weak force competes with humans on a daily basis. Gravity "A" of the strong force is the force that holds the solar system and universe in place. Energy from electrons represents the weak force. Energy inside the atom represents the strong force "A". Controlled resonate induction of any two of the three, changes into the third and is the motor that runs the Universe. We see this in the electrically induced magnetic thrust against gravity in electric motors. Weak force is required to dislodge electrons and strong force (atomic) to dislodge protons. Unless dislodged, these particles are of little value in producing electrical power.

Therefore, the particle of importance is the negative electron. Electrons have a "grudging" relationship with other electrons. This is to say they like each other, but especially at arms length. Therefore, we see charges of the same potential repelling charges of the same gender...like charges repel and unlike charges attract. This can be demonstrated by taking two batteries of the same type but at different charge levels (unequal potentials) and put plus and minus ends facing the same direction. Then, with a volt meter, measure the electrical potential between the two negative ends and the two positive ends. It is obvious the "more negative" moves to the "less negative" is the correct concept for electrical energy generation.

C.F. Gauss (1777-1855) and H.C. Oersted (1777-1851) both were separately trying to define the Earth's electrical field with external influences removed. These external influences being solar quiet periods and being remote from the land's surface. The air electricity background which they measured varies with latitude. Their European measurements correspond to approximately the latitude of Washington, D.C. They were measuring magnetic field flux as an indicator of negative electron energy active and present. A related family of measurement are now presented. Units of measure used to define flux fields include Gauss (one unit = 100,000 volts), Oersted (one unit = 50,000 volts), Tesla (one unit = 10,000 Gauss) and Gamma (one unit = 1/10,000 of a Gauss). Much confusion exists in electrical related publications about these units. As presented here they are correct with values taken from their original definitions.

The entire surface of the Earth has been surveyed by aerial magnetometer, in most cases using gamma or nano teslas. One gamma is the magnetic flux equivalent of 10 active volts of electricity. When the data is corrected for flight height it becomes obvious that there are numerous areas where the gamma readings exceed one trillion gammas. Lightning strikes from the ground up are in that energy range. With knowledge of these electron enriched areas, the quality of Earth grounding, becomes enhanced. The correction necessary for land surface data when acquired from aerial magnetometer maps (using Coulomb's law) requires that the remote distance be squared and then multiplied times the remote reading. As an example, the remote reading is 1,600 gammas and the flight height being 1,000 feet. Take $1,000 \times 1,000 = 1,000,000 \times 1,600$ gammas = 1.6 trillion gammas $\times 10$ volts = 16 trillion volts equivalent for land surface data. Present day methodology requires mechanical energy in exchange for electrical energy. Once obtained, this energy is subject to Ohm's Law. Present Methodology obtains it's electrical energy from it's non-metal and air groundings.

This same energy can be obtained without the wasteful mechanical approach and at a much, much lower cost. Any required amount of electricity is available by resonate induction transfer from the Earth's magnetic and electrical fields. The major difference is in the functioning of Ohm's Law in relation to resonate circuits. In the resonate induction system here suggested, system resistance (Z) becomes zero at resonance.

Therefore, volts and Amperes are equal (V.A.R.) until work (load) is introduced.

Each cycling of this resonate induction system pulls in additional electrons from the Earth's electrical field, generating electrical energy in any required amount. In this system, a small amount of electrical energy is used to activate and pull into the system a much larger amount of energy.

This electrical advantage corresponds to the pulley and lever of the mechanical world. The electrical system here presented is extremely efficient. Using present methodology as a basis for comparison, with it's 60 Hz. per second system. The resonate induction system, cycling at 60 million times per second produces one million times the energy produced by the present energy systems. A single small size unit of the resonate induction system has more usable electrical output than a major conventional unit. The radio frequency energy here produced is easily changed to direct current, then to the present 60 Hz. per second system in preparation for commercial usage.

*Patent Pending # 08/100,074, Electrical Energy Generating System,
4 February, 1992.

Definitions: Joule is one watt for one second
One watt is one volt ampere
V.A.R. is Volt Amperes Reactive

Additional

Reading: Electricity and Magnetism
By B.I. Bleany and B. Bleany
Oxford University Press 1991
I.S.B.N. 0-19-851172-8

Engineering Electromagnetics
By W. H. Hayt, Jr.
McGraw-Hill 1989
I.S.B.N. 0-07-027406-1

Continued:

Energy Methods in Electromagnetism

By P. Hammond

Oxford University Press 1986

I.S.B.N. 0-19-859368-6

Energy in Electromagnetism

By H. G. Booker

Institution of Electrical Engineers

by Peter Peregrinus Ltd. 1982

I.S.B.N. 0-906048-59-1

The American Radio Relay League Handbook for 1992 and
1993. 69th and 70th editions.

Published by The American Radio Relay League. (For V.A.R.
information)

I.S.B.N. 0-87259-169-7

Electron Paramagnetic Resonance, Techniques & Applications

By R. S. Alger, U. S. Naval Radiological Defense Laboratory,
San Francisco, California.

Pub. Interscience Lib. Congress #67-20255

Geomagnetic Diagnosis of the Magnetosphere

By A. Nishida, University of Tokyo 1978

Pub: Springer-Verlag

I.S.B.N. 0-387-08297-2

Energy and The Missing Resource

By I. Dostrovsky

Pub: Cambridge University Press 1988

I.S.B.N. 0-521-26592-4

High Voltage Measurement Techniques

By A. Schwab, M.I.T., 1971

I.S.B.N. 0-262-19096

Continued:

Environmental Magnetism
By R. Thompson & F. Oldfield
Pub: Allen & Unwin, London 1986
I.S.B.N. 0-04-538003-1

Geoelectromagnetic Investigation of the Earth's Crust and
Mantle.

Translated from Russian, By I. I. Rokityansky,
Institute of Geophysics, Kiev, U.S.S.R.
Pub: Springer-Verlag 1982.
I.S.B.N. 3-540-10630-8

Electron Paramagnetic Resonance of Transition Ions
By A. Abragam and B. Bleaney
Dover Publications, New York, N.Y. 1986

The Electromagnetic Field
By A. Shadowitz
Dover Publications, New York, N.Y. Date?

Geomagnetism, Several Volumes, Pub. Periodically
By J.A. Jacobs, Institute of Earth Studies, Dyfed, U.K.
Pub: Academic Press 1989-1990's.

Geomagnetism
By S. Chapman and J. Bartels, 3 Volumes
Oxford University Press, 1940

Physics of Geomagnetic Phenomena, Several Volumes
By S. Matsushita and W. H. Campbell
National Center for Atmospheric Research, Boulder, Colorado
Library of Congress #67-23168
Pub: Academic Press, 1967

Continued:

Physics Problems and How to Solve Them
By C. E. Bennett, Professor Emeritus of Physics,
University of Maine (Particularly the sections on Electricity and
Magnetism, and Units of Measure).
Pub: Harper & Row Date?
I.S.B.N. 0-06-460203-6

Units and Standards for Electromagnetics
By P. Vigoureux, National Physical Laboratory
Pub: Springer-Verlag 1971
I.S.B.N. 0-387-91077-8

Surveyor's Guide to Electromagnetic Distance
Measurement, Edited by J. J. Saastamoinen, Canada
Pub: University of Toronto Press Date?

Electromagnetic Distance Measurement
By C. D. Burnside
Pub: Granada, London 1971
I.S.B.N. 0-258-96793-5

Der Magnetische Kreis "The Magnetic Circuit"
By Von Heinz Rieger of Siemens AG. 1970
Berlin and Munchen, Germany
I.S.B.N. 3-8009-4719-6

Electronic Modeling of Power Electronic Converters
By J. A. Ferreira
Pub: Kluwer Academic 1989
33 AH Dordrecht, The Netherlands
I.S.B.N. 0-7923-9034-2

ELECTRICAL ENERGY WITH ASSOCIATED PHENOMENA

1. The effect of current results from the unequal distribution of negativity (electrons).
2. Electron spin causes electrical current and magnetic lines of force.
3. Magnetic imbalance causes the gravitational effect. This is evidenced in electric motors by magneto-gravitational displacement of mass which causes the motor to rotate.

ENERGY LINES OF FORCE FIELDS & WAVES *

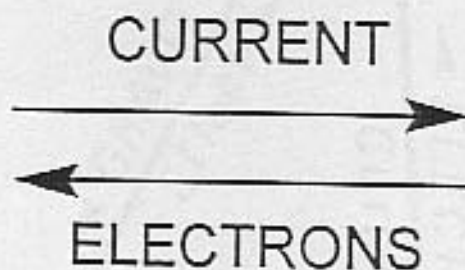

MAGNETIC EFFECT

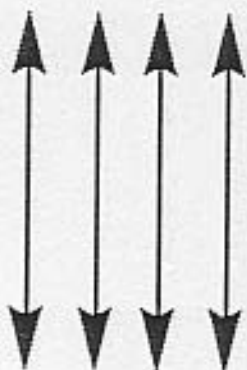

GRAVITATIONAL EFFECT

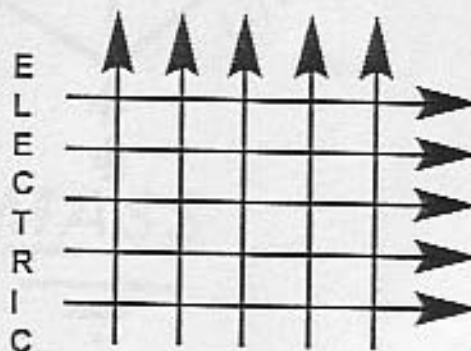

MAGNETIC

- * Below 20,000 Hertz per second = Fields
Greater than 20,000 Hertz per second = Waves (radio frequency).

ELECTRICAL ENERGY

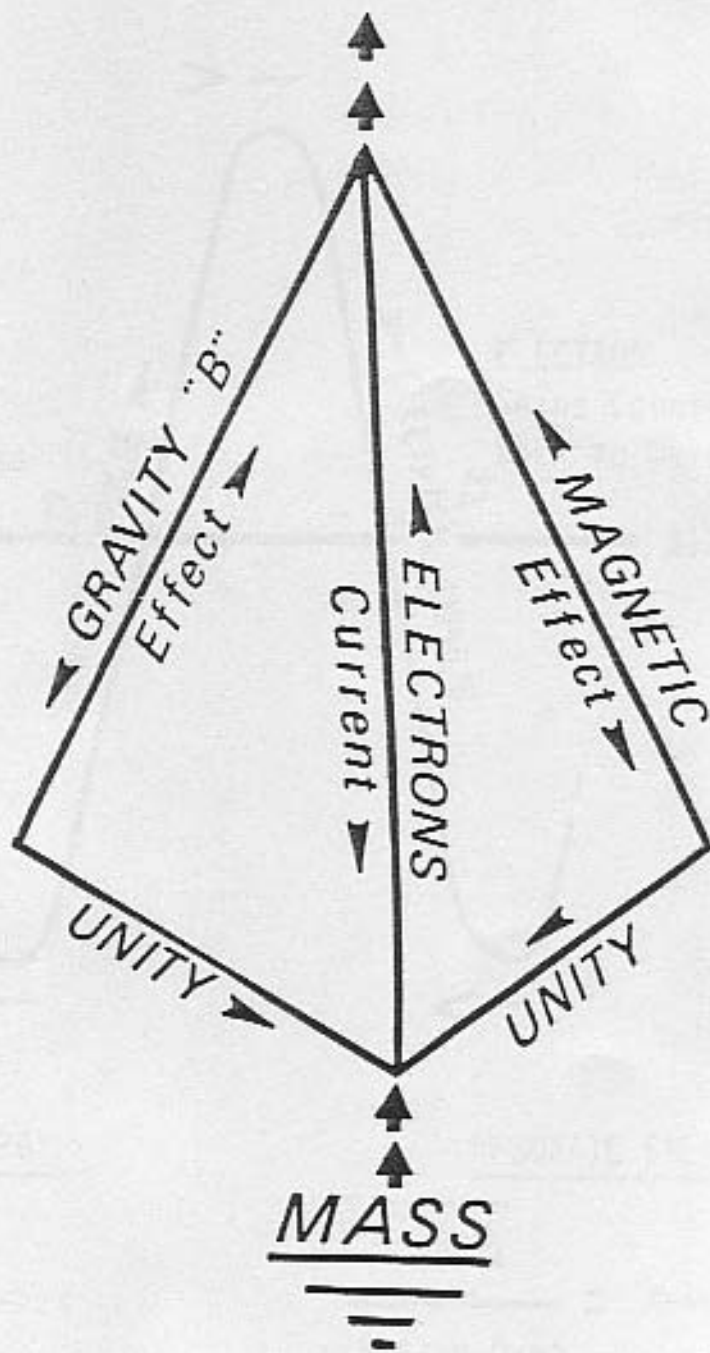

$$MC^2 = E$$

D.L.S., 93

ENERGY ACQUIRED BY MAGNETIC AND ELECTRICAL IMPULSING
 (ALTERNATING RESONATE ELECTRICAL POWER)

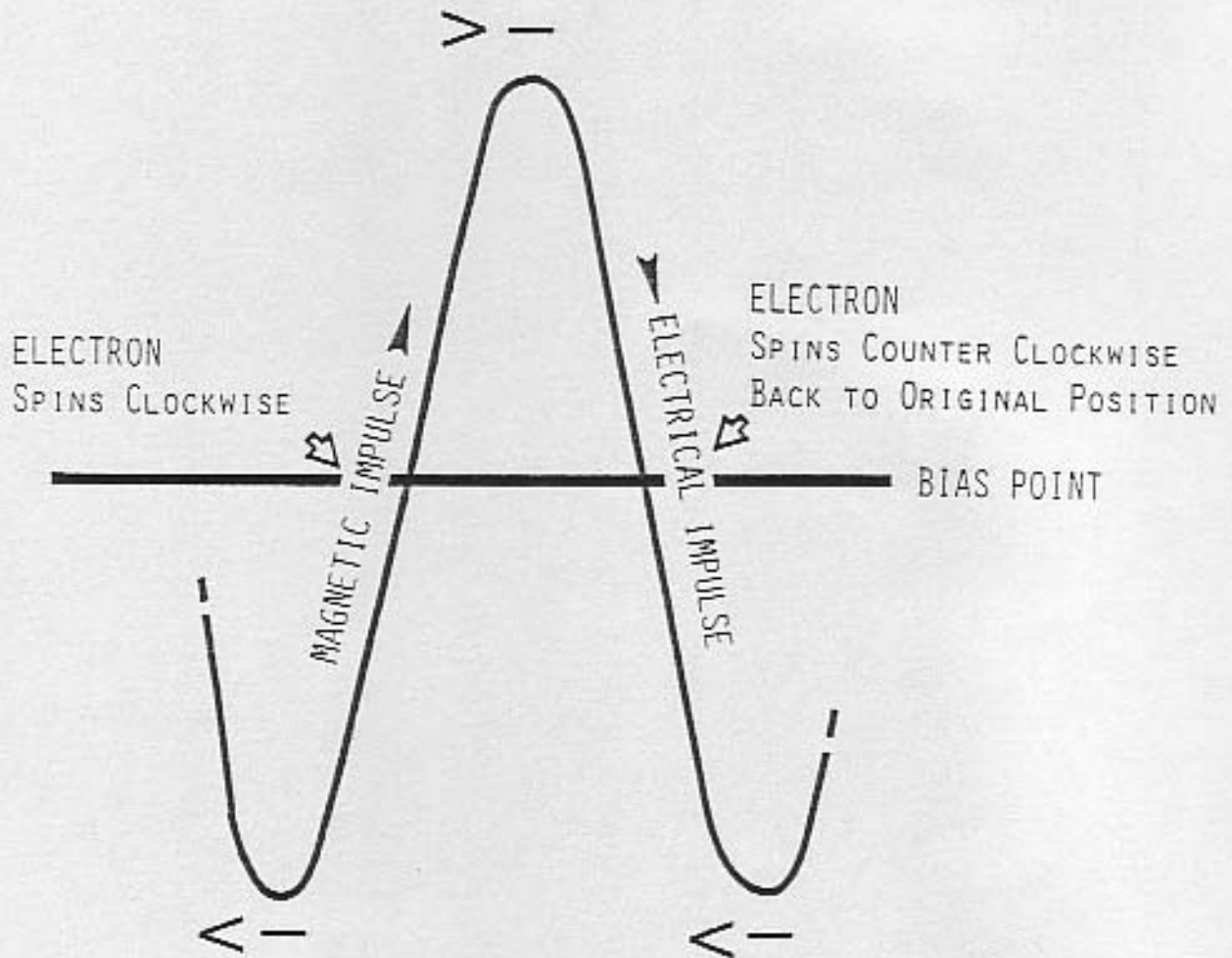

EXPECTED ENERGY

$$\frac{\text{VOLTS}}{\text{OHMS}} = \text{AMPERES}$$

RESONATE ENERGY

$$\frac{\text{VOLTS}}{\text{SYSTEM OHMS}} = \text{AMPERES}$$

SYSTEM OHMS BECOMES ZERO WHEN RESONATE, THEREFORE VOLTS AND AMPERES BECOME EQUAL, BEING VOLT AMPERES REACTIVE (V.A.R.).